

SOMMERFELD'S TOOLS

For Wood

TM

Sometimes Knowledge Is Your Best Tool...

Catalog 25

Price \$3.90



13-Pack Made
Easy Series

- ✓ See page 9 for all of our DVD's
- ✓ Check us out on YouTube at Sommerfeld Tools Channel
- ✓ Add to your own library
- ✓ 11 Hours of Instructions

Get All 13 How-To
DVD's For
ONLY \$39.90

A \$15.00 Savings!

Mix 'N Match
on ALL
Individual Bits!

Buy 2 SAVE 10%
Buy 3 SAVE 15%
Buy 4+ SAVE 20%

Order Line: 1-888-228-9268 Online: www.sommerfeldtools.com

In The Shop with Marc Sommerfeld...

The Only Thing That Surpasses The Quality Of Our Tools Is The Quality Of Our Customer Service...



I want to take a moment and highlight the following three people who make Sommerfeld customer service so special.

First is Pat, who many of you have spoken with many times and has been with us for over 17 years! She is the backbone of our company and all operations have her fingerprints on them in one way or another.

The second person is Susanne, who is new to us. Pat will be teaching her the **"Sommerfeld Way"** of excellence in customer service. I know she will excel.

The third person is a long time customer and good friend of mine from Oregon. Jay is a retired police officer, who became an accomplished cabinetmaker using many of our tools. If one of our girls can't answer your tech questions, I have great confidence that Jay will.

I'm also proud to let you know that you will always be talking with a real person when you call. Here are a few testimonials we have received to let you know what others are saying.



"I just wanted to take a moment and tell you how much of an impact you've had on my woodworking over the last two decades."

Everything (and I mean everything) you sell is the absolute highest quality and the longest lasting tools I have ever owned. I just wanted to say thank you for helping me to become a more advanced woodworker than I could have imagined 20 years ago." — T. Heagy

"I do not have the words to explain to you how great your products are. I see other companies trying to duplicate your stuff and they are not even close. Mr. Sommerfeld, thank you so much for all you have done to help me along the way." — B. Clapper

"I just received my first bit and used it several times today. I was so impressed with its performance that I needed to tell you how pleased I am. Great Product." — P. Nelson

Finally, I want to offer a special thank you to all of our loyal customers who have helped build our amazing company.

Best Regards,

Marc Sommerfeld

Table of Contents

ITEM	Page No	ITEM	Page No
2P10 Solo Adhesive	67	Leigh Jig Set	19
Abrasives	68,69	Letter Bits	54
Adjustable Roundover Bit	33	Lock Miter Bit 22.5°	46
Anglemaking Set	16	Lock Miter Bit 45°	47
Architectural Molding Set	21	Masters 6-Pc Jig Set	70
Baby Lock Miter Bit	47	Masters 7-Pc Craftsman Set	11
Beaded Face Frame System	17	Mini Router Set	25
Beading Bits w/Bearing	38	Mitered Molding Bit	19
Bearings	66	Molding Profile Bits	43,44
Bent Wrenches	6,66	Multi-Bearing Flush Trim Bit	5
Bevel Bits	35	Ogee Bits	40,41
Bird's Mouth Joint Bits	42	On/Off Switch	7
Blum Pozi Screw Driver	66	Ovolo Bits	32
Blumotion Drawer Slides	63	Panel Pilot Bit	31
Bull Nose Bits	36	Panel Pilot Bit	31
Cabinetmaking Set	13	Pattern Bits	35
Calipers	66	Picture Frame Rabbeting Bits	6
Chamfer Bits	38	Plunging Ogee Bits	33
Chamfer Set	21	Ply-Groove/Flush Trim Set	24
Classical Bits w/Bearing	39	Pocket Cutter	8
Classical Ogee Bits	40	Pocket Cutter Accessories	65
Classical Plunge Cut Bits	30,35	Prof. Cabinetmaking System	76
Clock Accessories	4	Project Plans	69
Combination Trimmer Bits	32	Push Blocks	66
Core Box Bit	31	Rabbeting Bits	45
Cove Bits w/Bearing	37	Rabbeting Sets	53
Cove Cutter	20	Rail & Stile Sets	56
Cove Set	23	Raised Panel Bits	57,58
Cove with Fillet Bits	39	Raised Panel Set	12
Dish Cutter Bit	29	Reversible Door Edge Bit	50
Door Lip Bit	50	Reversible Glue Joint Bit	47
Double Fillet Ogee Bit	41	Roman Ogee Bits	40
Double Roundover w/Bearing	55	Roundnose Bits	31
Dovetail Bits	32,59	Roundnose Set	24
Dovetail Jig	59	Roundover Bits	37
Drawer Edge Bit w/Bearing	49	Roundover Set	23
Drawer Lock Bit	48	Router Table/Fence	7
Drawer Pull Bits	50	Routers	6
Drawer Runners	63	Rubber Glass Retainer	14,15
Drawer Slide Jig	63	Rubber Grommet	6
DVDs	9	Saw Blades	60,61
Easy Bore Hinge Boring Jig	62	Screws	65
Easy Mark	70	Shaker Set	14
Easy Set	46	Shaker/Glass Set	14
Edge Beading Bits	36	Shutter Set Accessories	5
Edge Molding Bit 135°	48	Slot Cutter Set	52
Face Clamps	65	Slot Cutters	51,52
Face Frame V-Groove Trimmers	54	Spiral Bits	28
Featherguard	8	Stair Tread Bit	27
Finger Joint Bit	42	Starter Set	22
Flush Trim Bits	28,34	Stop Collar	59,65
Flute & Bead Bits	33	Straight Bits	26,27,28
Forstner Set	67	Table Edge Bits	49
Full Bead Bit	33	Tape Measures	64
Glass Panel Set	14,15	Templates	71
Glubot's	64	Tongue & Groove	10
Glue Joint Set	18	Tongue & Groove Pro	10
GluNip	64	Trend Tool Cleaner	67
Groove & Bead Forming Bits	30	Triple Bead Bit	43
Hand Rail Bits	45	V-Groove Bits	30
Hinge Mortising Bits	29	V-Tongue & Groove Bit	54
Hinges	62	Variable Slot Cutter Set	51
Incra Joint Set	25	Veining Bit	54
Introductory Set	22	Vertical Panel Raiser Bits	55
Jointmaking Set	18	Wavy Edge Bit	55
Jr. Raised Panel Set	20,69	Window Sash Bit	42
Jr. Templates	71	Window Shutter Set	5
Keyhole Bits	29		

Why Sommerfeld's Router Bits Are Your Best Choice

Custom Formulated Super-Fine-Grain Carbide with Titanium

Designed to outperform the leading European style micro-grain carbide router bits

- Higher wear resistance
- Longer cutting life
- CNC center-point turning
- Anti-kickback design for added safety
- Enhanced thermal shock resistance
- DuPont® non-stick coating
- Superior results on abrasive materials
- Larger bits are dynamically balanced
- Forged steel bodies for higher density and higher tensile strength

*Forged steel bodies applies to 1-1/2" dia. & larger bits

With recent advancements in cutting technology, the terminology used to describe micro-grain carbide has changed to further define the substructure of the carbide powder. The terms **Fine-Grain**, **Ultra-Fine Grain** and **Super-Fine Grain** carbide represent varying levels of smaller and smaller particles. The smaller carbide grain sizes are able to absorb more binder, resulting in harder carbide with higher structural integrity.



The inclusion of **Titanium** provides improved performance under higher temperature, which helps retain sharpness and provide a longer cutting life for the tool.

The custom formulated **Super-Fine-Grain** carbide with **Titanium** used in the production of Sommerfeld router

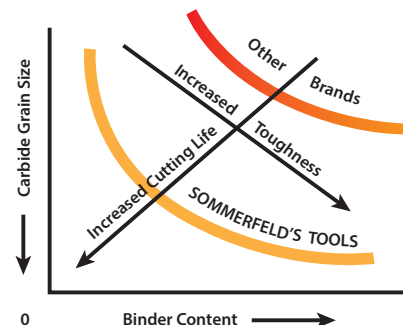

bits represents the perfect combination of hardness, wear resistance and overall toughness. Our bits are engineered for optimal performance across a wide range of solid wood, wood composite materials and plastics. Sommerfeld router bits are designed to perform better in production use, which is why professionals trust Sommerfeld's Tools over other leading brands. We also stand behind the quality of our bits and guarantee your satisfaction.

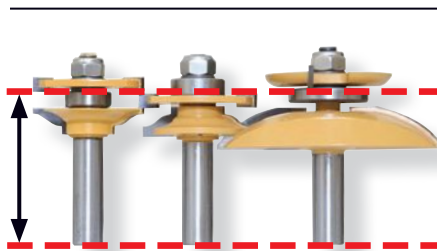

Height-Matching - All mating cutters are perfectly aligned relative to the bottom of the bit shank. This makes for exceptional cutting tools that ultimately produce better fitting joinery with less hassle for the woodworker.

Height-Matched Router Bit Sets

- Faster set-ups on matched sets
- Less scrap from failed trial and errors
- No hassle, just set it and forget it
- Switching between bits is easy

Here's why you'll want our Height-Matched Bit Sets

Every routing expert and book offers the same law of router bit insertion:

"Insert the bit until it bottoms-out in the collet seat – then retract it 1/16" to 1/8" before tightening."

Here's why - the collet is tapered on the outside, so that when the collet nut is tightened, the collet draws downward and compresses around the router bit shank. This also draws the bit down slightly. If the bit is bottomed out to begin with, it has no room to travel, and therefore, the collet cannot be tightened properly.



Sommerfeld's bits are manufactured to the highest standards using custom CNC machining centers with five-axis grinding

A simple rubber grommet provides the solution

Inserting a 1/2" diameter rubber grommet in the bottom of the bit shaft accomplishes two important objectives. One, it allows the bit to safely bottom-out against the grommet, and as the collet nut is tightened, the rubber grommet compresses slightly to allow the collet to draw down and secure the router bit properly.

Secondly, the rubber grommet also provides a consistent starting position for our Height-Matched router bits. This allows our matched sets to be perfectly aligned every time...eliminating the need for multiple router bit height adjustments.

Set the height for one bit, and the other mating bits will position and align perfectly

Our Height-Matched bits allow you to set your bit height once, and the other Sommerfeld bits that are designed to mate with it will align perfectly when tightened into the collet. *Fast. Easy. Foolproof.*



In the photo (left), a bit is inserted into a collet with the collet nut in position.

Note: The bottom of the split collet protruding below the nut and the bottom of the bit shank rests on the rubber grommet.

Everything You Need To Build Sommerfeld's Grandfather Clock

This collection gives you the ability to create a clock that you can pass down for generations! Clock movements are available at www.clockworks.com or call **800-381-7458**

Build a 7-Foot Tall Heirloom Clock with One Great Package!



3-Pc Cove Raised Panel



3-Pc Tongue & Groove Cabinetmaking Set



3-Pc Glass Panel Door Set

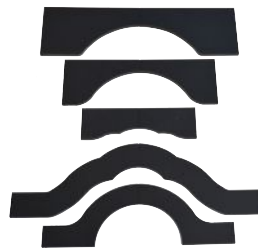

Sommerfeld's Clock Template Set



Table Edge Bit



Super Duty Flush Trim Bit w/ Bearing



Brown Rubber Glass Panel Retainer
(Also Available in Clear: GLASSW)

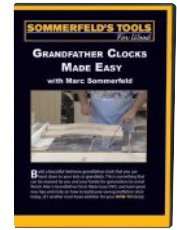

Grandfather Clocks Made Easy DVD



10-Pages of Design Plans

Grandfather Clock Accessories

Grandfather Clock Hardware



Surface Mount Lock with Key & Escutcheon

Threaded Fixed Base Leveling Glides

Self Closing Partial Wrap 3/8" Hinges



Item	Description	Sale
03011	3-Pc. Glass Panel Door Roundover Set	\$139.90
03003	3-Pc Glass Panel Door Ogee Set	\$139.90
03004	3-Pc Tongue & Groove Cabinetmaking Set	\$109.90
03001	3-Pc Cove Raised Panel Set	\$159.90
03008	3-Pc Ogee Raised Panel Set	\$159.90
39501	Surface Mount Lock with Key & Escutcheon	\$13.90
521902B	Super Duty Flush Trim Bit w/ Bearing	\$30.90
716352C	Table Edge Bit	\$55.90
BLG	Threaded Fixed Base Leveling Glides w/ Round Nuts (4 Required)	\$5.90 ea
BP7565ORB	Self Closing Partial Wrap 3/8" Hinges (3 Required)	\$7.90 ea
DVD13	DVD Grandfather Clock Made Easy	\$9.90
FSCLTMP	Large Grandfather Clock Templates	\$59.90
LCP	Large Grandfather Clock Plans (DVD13 included with plans)	\$19.90
GLASS	25' Roll Brown Rubber Glass Panel Retainer	\$14.90



Multi-Bearing Flush Trim Bits

Sommerfeld's **NEW** Multi-Bearing Flush Trim Bits allow for quick and easy setup whether the template is on top or the bottom

Sommerfeld's New Multi-Bearing Flush Trim bits allow you to quickly and easily flip your work piece to put the template on the top or bottom. This allows you to cut with the grain on each pass yielding a smoother, cleaner cut every time.

Simply raise or lower the bit in table to quickly adjust your workpiece. This is especially useful when cutting curves which run both with and against the grain.

Cut from either direction using one template and without moving the template to the other side of the work piece.

The down-shear design helps to eliminate tear-out with less vibration. Best used in a router table where template is visible to bearing.

The New Multi-Bearing Flush Trim bits allow you to use a top or bottom mounted workpiece template

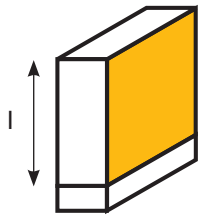
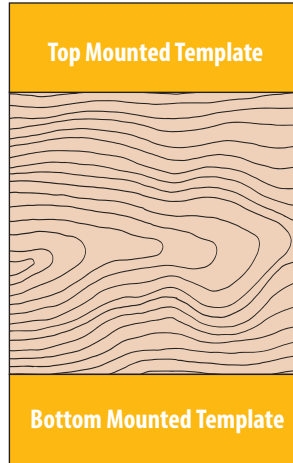

ITEM	D Cutting Diameter	I Cutting Length	L Overall Length	S Shank Diameter	Bearing	Sale
01022	1/2"	1"	2-5/8"	1/4"	R3ZZ, R188ZZ	\$20.90
01023	7/8"	1-1/2"	3-1/2"	1/2"	HC222CZZ, HC223CZZ	\$29.90
01024	3/4"	2"	4-5/16"	1/2"	SRI1212ZZ, R266ZZ	\$55.90

3-Pc Window Shutter Set

Now you can build movable louvered shutters quickly and easily with Sommerfeld's Window Shutter Set. Save thousands of dollars by building your own plantation shutters. Max stock of 3/4" but 3/8" to 1/2" is ideal.

3-Pc Window Shutter Set Accessories

Below: The nylon shutter pin is for 2-1/2" and 3-1/2" louvers. They support the louvers in the shutter panel, and allow the louver to rotate. The narrow end of the shutter pin is inserted into the louver. The larger end of the shutter pin is inserted into the stile or frame.



Item #SCAF

Item #SLP



* Not shown actual size

Above: Used with our Window Shutter Set, these Shutter Control Arm Fasteners are easy to install by hand or using a needle-nose pliers. The fasteners keep your shutter control arm attached to the louvers without taking away from your design.

HALF-PRICE



HOW-TO DVD
With Purchase of The Window Shutter Set Made Easy

A \$9.90 VALUE

Yours for only \$4.⁹⁰
DVD: DVDS12

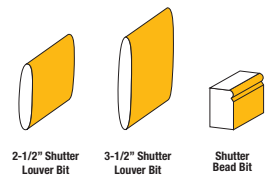

2-1/2" Shutter Louver Bit 3-1/2" Shutter Louver Bit Shutter Bead Bit

ITEM	Description	Shank Diameter	Sale
SCAF	Shutter Control Arm Fasteners (30 per pk)	1/2"	\$9.00
SLP	Nylon Shutter Pin (30 Pack)	1/2"	\$3.00
03009	Sommerfeld's Window Shutter Set	1/2"	\$99.90

Sommerfeld's Picture Frame Rabbeting Bits

Now you can protect your custom made mirrors, glass and picture frames with strong backer board material!

This double stepped rabbet cutter cuts one rabbet for your glass, mirror or picture and follows up with another rabbet for a piece of backer board. This backer board can be screwed in to protect and cover your mirror, glass or picture.

RB002A - Cuts a 1/8" deep by 3/8" wide slot for your material. This bit cuts a 3/8" wide slot for your backer material with a maximum thickness of 3/8".

RB002B - Cuts a 1/4" deep by 3/8" wide slot for your material. This bit cuts a 3/8" wide slot for your backer material with a maximum thickness of 3/8".



RB002A



RB002B

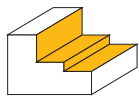

RB002A

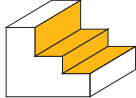

RB002B

ITEM	Description	Cutting Dia.	Cutting Length	Overall Length	Shank	Bearing	Sale
RB002A	Picture Frame Rabbeting Bit	1-7/8"	15/32"	2-13/32"	1/2"	R2ZZ	\$39.90
RB002B	Picture Frame Rabbeting Bit	1-7/8"	19/32"	2-17/32"	1/2"	R3ZZ	\$39.90



3-1/4 HP Variable Speed Plunge Router

For convenience...muscle...and value...you can't beat this Down-Under-Designed Triton Router. In fact, Marc liked them so much, the mounting holes* for it are pre-drilled in the surface of every Sommerfeld's Routing System Table.

The built-in shaft lock and single wrench system make bit changes quick and easy. Rotate the speed dial to match your speed to the material and bit you're using and say goodbye to burning. Use the button on the winder knob to select rack-and-pinion or free plunge mode. Ideal for use with Sommerfeld's Router Table System!



ITEM # TRA001
3-1/4 Triton Plunge Router
SALE: \$249.⁹⁰



3-1/4 HP

Specifications	TRA001
Power	3-1/4 Hp
Amperage	15 A
Speed Control	Variable speed with soft start & continuous speed control under load
RPM Range	Infinitely adjustable - 8,000 to 21,000 rpms
Collets Included	1/2" (w/ 1/4" collet adaptor)
Micro-Adjustment	Infinite throughout full plunge range
Through-Table Depth Adjustment	Yes - height adjustment crank included
Weight	13.5 lbs.
Warranty	3 Years
Country of Origin	Taiwan - (Australian designed)

* NOTE: All Sommerfeld's Routing System tables come with the mounting holes for this Triton router (as well as the hole to accommodate the Winder Handle) pre-drilled in the table surface. *Just bolt them together and go to work!*

TRITON ROUTER WARRANTY - ALL WARRANTY ISSUES AND SPARE PARTS WILL BE RESOLVED BY TRITON TOOLS EXCLUSIVELY: 980-297-7257. Customers are responsible for the shipping expense of all returns - No exceptions.



WR003 Bent Wrench for Triton 3-1/4 HP Router
Save \$4.90 when purchased with router!
SALE: \$10.⁰⁰

RBR/32828352
Rubber Grommet
SALE: \$.49



SUGGESTED ROUTING SPEEDS	
Bit Diameter	Maximum Speed
1" (25 mm)	24,000 RPM
1-1/4" - 2" (30-50mm)	18,000 RPM
2-1/4" - 2-1/2" (55-65mm)	16,000 RPM
3" - 3-1/2" (75-90mm)	12,000 RPM



Sommerfeld's Router Table System

This may not be the first router table you've ever owned, but once you've tried it out, you're certain to agree that it's the last one you'll ever need!



Our Aluminum Router Table is designed by Marc Sommerfeld and extruded in the USA... It's dimensionally stable and precision engineered

Router tables are amazingly versatile tools, but they're only as good as they are true, and dimensionally stable in a changing environment. For example...

- The trueness of tables made from glued-up hardwoods or laminate-covered composites can be affected by changing environmental conditions. **Not Ours!**
- Small tables and fences don't provide adequate workpiece support, allowing the stock to move off-path, ruining the cut. This system is **ULTRA** supportive.
- If adjustments aren't fast and simple, valuable production time will be lost. There's no alignment required, no scales to read and only one knob to adjust with **Sommerfeld's Router Table System!**



Bent Wrench



Optional Remote Switch #1043

*Not Included with Table



A full color instruction booklet and DVD are included **FREE**



Make Zero Clearance Fence Inserts to match your bits. 3 blanks included.

*Bit not included with table



Solid, 1/2", 3/4", 1", 1-1/4", 1-1/2", 2" & 2-5/8" twist-lock Insert Rings.

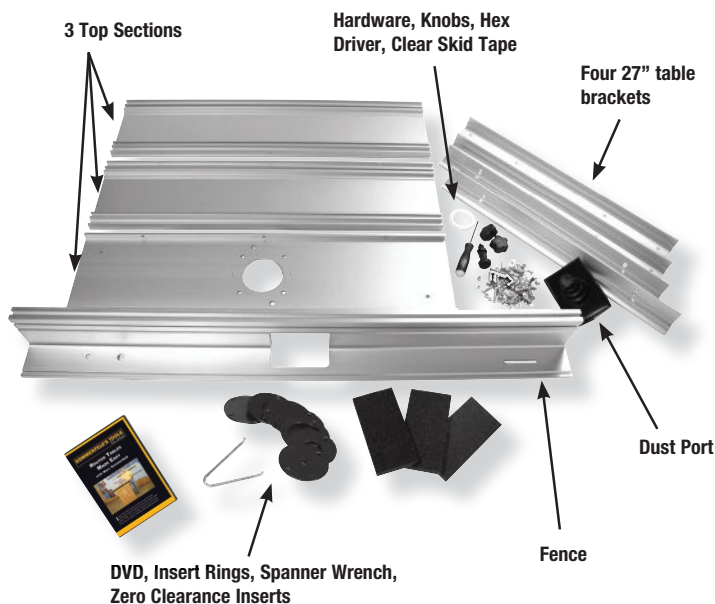

Nearly 7 square feet of rock-solid surface area to support your workpieces during operations

- **TOP INCLUDES:** (8) twist-lock Insert Rings (Solid, 1/2", 3/4", 1", 1-1/4", 1-1/2", 2", 2-5/8" openings) Spanner Locking Wrench, DVD3 Router. Tables Made Easy, assorted mounting hardware, and a 16-page full-color instruction book. Table sections fit within a .025 tolerance. The starter pin has been eliminated from our router table package since most of our customers use the half-fence method demonstrated in Marc's DVD1 Raised Panels Made Easy.
- **FENCE INCLUDES:** (2) HDPE Sub-fences, (3) Zero clearance inserts, 4-step Dust Port, 5/32" Allen driver, Fence Guard, 9/16" x 4 and 7/8" x 4 tapes and assorted mounting hardware.

ITEM	Description	Sale	Shipping
SOT	Sommerfeld's Top 36" x 27"	\$339.90	\$22.50
SOF	Sommerfeld's Fence 48" x 4-3/4"	\$229.90	\$32.40
SORS	Sommerfeld's Router System	\$549.90	\$54.90

Optional Router Table Accessories			
CPG	Clear Plastic Fence Guard (Included with Fence)		\$3.90
DP001	Dust Port (Included with Fence)		\$5.90
SOM #7	Pivot Pin (Included with Fence)		\$29.90
Router Table Rings	Router Table Rings (8) Plastic (Included with Table)		\$39.90
Spanner Wrench	Spanner Wrench (Included with Table)		\$6.90
WR001	Bent Wrench - 1-1/8"		\$14.90
WR002	Bent Wrench - 13/16"		\$14.90
WR003	Bent Wrench - 15/16"		\$14.90
WR004	Bent Wrench - 7/8"		\$14.90
ZCI30	Zero Clearance Inserts (3) (Included with Fence)		\$19.90
1043	Remote ON/OFF Switch		\$24.90
DVD3	Router Tables Made Easy (Included with Table)		\$9.90

Sommerfeld's 3-In-1 Pocket Cutter

*All die-cast aluminum construction
No plastic parts and molded carry case*

Pocket Hole Joinery has been in the woodworking industry for over 20 years. The 3-in-1 Pocket Cutter from Sommerfeld's goes back to the basics - back to heavy duty construction - back to simple functionality!

During the construction of a cabinet we recommend the use of a pocket-hole joint in the fastening of the face frame only. It is excellent there and 100% hidden from view.

This jig can be used by beginners or professionals alike. With the large, powerful toggle clamp, placing and holding your stock firmly in position couldn't be easier. The jig also comes with two separate drill guides that can be easily swapped out for different thicknesses of stock - the small guide works with 3/4" stock and the large guide works with 1-1/2" stock. Our Pocket Cutter comes with 2-1/2" and 3-1/2" Face Clamps.

Each guide has hardened steel bushings with a lifetime warranty against wearing. Each drill guide incorporates a rare earth magnet for attaching the drill guide to a clamp for portable pocket hole joinery.



Pocket Cutter comes in a molded plastic carrying case

3 Ways To Use...



3/4" Stock



1-1/2" Stock



Portable Use

ITEM	Description	Sale
31PC	Sommerfeld's 3-In-1 Pocket Cutter	\$89.90

Sommerfeld's Unique Featherguard

With Marc Sommerfeld's featherguard, you get two great tools in one! This is the only featherboard that acts as a guard as well.

Great for use on your router table or table saw.

The only featherboard that doubles as a 100% safe guard when used correctly - no part of the bit is exposed to your hands. Knobs and hardware are included to attach to a 1/4" track. The feather guard is also set up for our 5/16" track.



- ✓ Great for large pieces of plywood.
- ✓ Works great on raised panel doors.
- ✓ Make cuts accurately and safely at the same time.
- ✓ Unique design allows for over 50 lbs. of pressure.
- ✓ The guard portion completely covers the router bit.
- ✓ Can be used as a featherboard and a guard at the same time.
- ✓ Can use two at the same time - one vertically and one horizontally.
- ✓ Knobs and hardware included to attach to your router table or table saw.

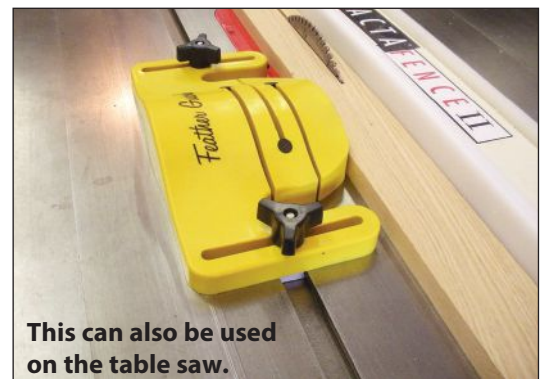

This can also be used on the table saw.



Used as a guard



Used horizontally



Used vertically



Two guard setup

Sommerfeld's Featherguard

Item #FG **\$24.⁹⁰**

Buy Two For Only \$39.⁹⁰

Marc Sommerfeld's Expanded DVD Collection

A wealth of woodworking knowledge "Made Easy," presented by master craftsman Marc Sommerfeld

We offer all of our DVD's in one 13-pack DVD set containing over eleven hours of woodworking "How-To" knowledge featuring Master Cabinetmaker Marc Sommerfeld, one of the nation's leading experts on cabinetmaking techniques. This mini-library of woodworking techniques covers the full range of cabinetmaking, from cabinet doors and face frame construction to plantation shutters, arched raised panel doors, glass panel doors, mitered raised panel doors and more. We also sell each DVD individually, or discounted when purchased with qualifying bit sets! * DVD's are non-refundable once opened.

Marc's Expanded DVD Collection



We offer all of our DVD's in one 13-Pack DVD set containing over eleven hours of woodworking "How-To" knowledge featuring Master Cabinetmaker Marc Sommerfeld. DVD length 11 Hours.

DVD13PK 13-Pack Made Easy Series ~~\$54.99~~ **\$39.90**

Mitered Raised Panels Made Easy



In this information-packed DVD, Marc will lead you step-by-step through a surprisingly simple approach to building beautiful mitered raised panel doors from a custom 3" wide molding that you create using your router table. DVD length 42 minutes.

DVD7 Mitered Raised Panels Made Easy **\$9.90**

Arched Raised Panels Made Easy



Arched panel doors are the perfect way to make your work truly unique and distinctive, and this DVD from Marc Sommerfeld shares all the secrets of the master doormaker. DVD length 30 minutes.

DVD1 Arched Raised Panels Made Easy **\$9.90**

Dovetails Made Easy



In this information-packed DVD, Marc will show you in a step-by-step approach how to create five different dovetails with the versatile & easy-to-use Dovetail Jig. DVD length 38 minutes.

DVD8 Dovetails Made Easy **\$9.90**

Glass Panel Doors Made Easy



Learn the master's secrets for building the finest Glass Panel & Divided Light Doors, as Marc shows you how to get the most out of your Sommerfeld Glass Panel Set. DVD length 30 minutes.

DVD2 Glass Panel Doors Made Easy **\$9.90**

Angle Making Made Easy



In this DVD, Marc will show you in a step-by-step approach how to cut curves and angles easily with the Sommerfeld Angle Making Set! DVD length 20 minutes.

DVD9 Angle Making Made Easy **\$9.90**

Router Tables Made Easy



Build your own customized router table, or get the most from your Sommerfeld's Routing System. DVD length 120 min.

DVD3 Router Tables Made Easy **\$9.90**

Beaded Face Frames Made Easy



In this DVD, Marc will show you in a step-by-step approach how to use his Beaded Face Frame cutter on your table saw. DVD length 22 minutes.

DVD10 Beaded Face Frames Made Easy **\$9.90**

Cabinetmaking Made Easy



Beautiful cabinetry doesn't have to be difficult. From face frame to hardware installation, Marc covers it all! DVD length 105 minutes.

DVD4 Cabinetmaking Made Easy **\$9.90**

Curved Cabinets Made Easy



In this DVD, Marc will show you step-by-step how to build stile and rail cabinetry that looks like it curves! He demonstrates his method of making stile and rails look like they are actually curving around a corner! DVD length 50 minutes.

DVD11 Curved Cabinets Made Easy **\$9.90**

Shaker Raised Panels Made Easy



In this fast-paced, half-hour DVD, Marc will lead you step-by-step through building three different types of Shaker-style raised panel doors. DVD length 30 minutes.

DVD5 Shaker Raised Panels Made Easy **\$9.90**

Window Shutter Set Made Easy



In this DVD, Marc will show you step-by-step how to build movable louvered shutters quickly and easily with Sommerfeld's Window Shutter Set. Save thousands of dollars by building your own plantation shutters. DVD length 30 minutes.

DVD12 Window Shutter Set Made Easy **\$9.90**

Mini Raised Panels Made Easy



Arched raised panels aren't just for kitchen cabinets anymore, thanks to Marc Sommerfeld's Mini Raised Panel techniques. DVD length 30 minutes.

DVD6 Mini Raised Panels Made Easy **\$9.90**

Grandfather Clocks Made Easy



Marc will show you how to build a beautiful heirloom grandfather clock that you can hand down for generations. This is something that can be enjoyed by you and your family for years to come! DVD length 2 hours.

DVD13 Grandfather Clocks Made Easy **\$9.90**



4-Pc Tongue & Groove Cabinetmaking PRO Set

This set includes a unique 4" tall mitered molding bit used to create decorative 3" wide stile & rail stock for mitered cabinet doors... Then switch to tongue & groove bits to create spline-like corner reinforcements

- Tongue & Groove bits are perfectly matched in cutting height for fast, no-hassle set-ups
- Includes 2 different sized bearings, one for 1/4" tongue & groove for cabinetmaking and another for 1/2" tongue & groove for mitered raised panel doors
- Machines material from 3/4" to 1-1/8" thick

HALF-PRICE



HOW-TO DVD
With Purchase Of The
Tongue and Groove Pro Set
A \$9.90 VALUE

Yours for only \$4.⁹⁰
DVD: DVDS7



Box has flush-mounted magnetic catch.

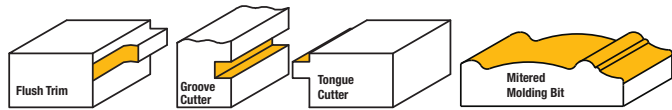

ITEM	Description	Bearing	Shank Diameter	Sale
02003	1/2" Shank Tongue & Groove Cutters (2 Bit Pair)	HC318DZZ / 698ZZ	1/2"	\$99.90
01019	1/2" Shank Flush Trim Cutter	R3ZZ	1/2"	\$19.90
01010	1/2" Shank Mitered Molding Bit	R4ZZ	1/2"	\$89.90
01010SM	1/2" Shank Small Mitered Molding Bit	R4ZZ	1/2"	\$56.90
04001	4-Pc Tongue & Groove Cabinetmaking Pro Set			\$266.60

3-Pc Tongue & Groove Cabinetmaking Set

Build stronger, better fitting cabinets with less work using Marc Sommerfeld's fail-safe Cabinetmaking System and these bits!

- Tongue & Groove bits are perfectly matched in cutting height for fast, no-hassle set-ups
- Allows an efficient means of building perfectly square fitting and stronger cabinetry and furniture casework
- Machines material from 3/4" to 1-1/8" thick



HALF-PRICE



HOW-TO DVD
With Purchase Of The
Tongue And Groove Set
A \$9.90 VALUE

Yours for only \$4.⁹⁰
DVD: DVDS4

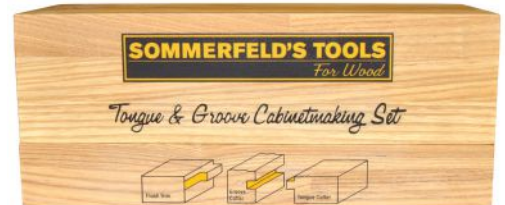

Box has flush-mounted magnetic catch.

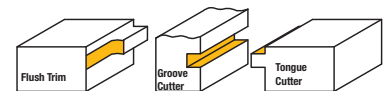

Minimum Stock Thickness - 3/4"
Maximum Stock Thickness - 1-1/8"

ITEM	Description	Bearing	Shank Diameter	Sale
02003	1/2" Shank Tongue & Groove Cutters (2 Bit Pair)	HC318DZZ / 698ZZ	1/2"	\$99.90
01019	1/2" Shank Flush Trim Cutter	R3ZZ	1/2"	\$19.90
03004	3-Pc Tongue & Groove Cabinetmaking Set		1/2"	\$109.90

The Official Sommerfeld's Tools for Wood YouTube Channel is Available Online!

Go to www.YouTube.com and search, "Sommerfeld's Tools Channel"



Sommerfeld's "Made Easy" Series is Available Online!

You can now view many of our instructional DVD's online before purchasing a copy for your own library! In all of our Made Easy DVD's, Marc utilizes his decades of woodworking knowledge to help you get the most out of your tools. His step-by-step approach will help you hone your woodworking skills, as well as teach you how to use many Sommerfeld products, so start utilizing this great resource today! Of course, don't forget, where slow internet connections, or weak WiFi signals make video streaming unreliable, you can simply buy a Made Easy DVD copy for your video library, and never miss a single step.



Sommerfeld's 7-Pc Master Craftsman Set

Begin with a solid foundation using our most popular woodworking tools, accessories and DVD's — all yours at a savings of \$68.30



3-Pc Tongue & Groove Cabinetmaking Set

Marc's Expanded DVD Collection



Cabinetmaker Blade



3-Pc Shaker Set

16 oz GluBot Bottle



3-Pc Tongue & Groove Cabinetmaking Set



3-1/4 HP Variable Speed Plunge Router
Triton Router



Sommerfeld's Unique Featherguard

ITEM	Description	Sale
31003	Cabinetmaker Blade	\$59.90
FGx2	Featherguards x 2	\$39.90
3004	3pc. Tongue & Groove	\$109.90
3005	3pc. Shaker Set	\$149.90
TRA001	Triton Router	\$249.90
GluBot	16 oz GluBot Bottle	\$7.90
DVD13PK	DVD 13 Pk	\$54.90
	Total Retail Value	\$672.30
	YOU SAVE	\$67.23
SMCS	Sommerfeld's 7-Pc Master Craftsman Set	\$605.07



3-Pc Raised Panel Door Set

Craft beautiful professional-looking raised panel doors for cabinets and furniture

- All bits are height-matched for fast, no-hassle set-ups
- Full 1/2" engagement on rail and stile for stronger joints & easier measurement of door part dimensions.
- Radiused-Corner-Geometry on our Rail and Stile bits relieves stress as it prevents the edge tear-out that is a common problem with other brands.
- Large 3-1/2" diameter Raised Panel bit with back cutter
- Machines material from 3/4" to 7/8" thick
- The 3 and 6 piece sets include a raised panel cutter with 2 bearings. It comes with the large bearing installed. If you are making arched or curved raised panels the large bearing allows you to make half the cut since there is no fence involved. After the first cut you change bearings and install the small bearing to finish the cut. If you are doing straight raised panels, you can go immediately to the small bearing and take 2 passes by simply moving the fence.



03001

Box has flush-mounted magnetic catch.

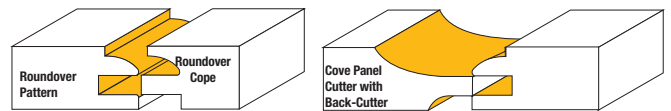

Sommerfeld's Patented Radiused-Corner-Geometry Rail & Stile Bits

Patent Number US 8,491,980 B1

HALF-PRICE



HOW-TO DVD
With Purchase Of The
Raised Panel Set
A \$9.90 VALUE

Yours for only \$4.90
DVD: DVDS1

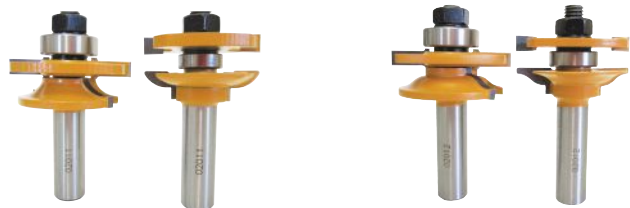

Roundover Rail & Stile Set
ITEM # 02011

Ogee Rail & Stile Set
ITEM # 02012

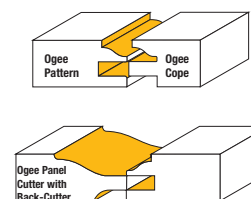
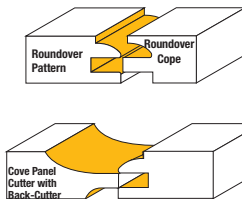

Radiused-Corner-Geometry on our Rail & Stile bits relieves stress as it prevents the edge tear-out that is a common problem with other brands

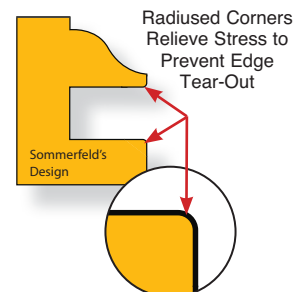

ITEM	Description	Bearing	Shank Diameter	Sale
01001	Shank Cove Raised Panel Cutter w/Back Cutter	HC318DZZ / 688ZZ	1/2"	\$89.90
02011	Shank Roundover Rail & Stile Bits (2 Bit Pair)	698ZZ / 608ZZ	1/2"	\$99.90
03001	3-Pc Cove Raised Panel Set			\$159.90
01015	Shank Ogee Raised Panel Cutter w/Back Cutter	HC318DZZ/688ZZ	1/2"	\$89.90
02012	Shank Ogee Rail & Stile Bits (2 Bit Pair)	698ZZ/608ZZ	1/2"	\$99.90
03008	3-Pc Ogee Raised Panel Set			\$159.90



6-Pc Cabinetmaking Set

An expanded raised panel door set with bits for drawer fronts and door edges



- All bits are height-matched for fast, no-hassle set-ups
- Full 1/2" engagement on rail and stile for stronger joints and easier measurement of door part dimensions.
- Radiused-corner-geometry on our Rail and Stile bits relieves stress as it prevents the edge tear-out that is a common problem with other brands.
- Large 3-1/2" diameter raised panel bit with back cutter
- Machines material from 3/4" to 7/8" thick
- The 3 and 6 piece sets include a raised panel cutter with 2 bearings. It comes with the large bearing installed. If you are making arched or curved raised panels the large bearing allows you to make half the cut since there is no fence involved. After the first cut you change bearings and install the small bearing to finish the cut. If you are doing straight raised panels, you can go immediately to the small bearing and take 2 passes by simply moving the fence.
- The drawer front bit is made much larger in diameter for a deeper cut, plus we added the Roundover at the bottom to give it an Ogee look. Now your drawer front matches the door front edge detail.
- The door edge bit was also made larger, plus shallower to allow for ease of mounting 35mm European hinges.
- The matching flush trim bit has a shear angle to produce superior cuts.



06001 Box has flush-mounted magnetic catch.



Sommerfeld's Patented Radiused-Corner-Geometry Rail & Stile Bits

Patent Number US 8,491,980 B1

HALF-PRICE



HOW-TO DVD
With Purchase Of The
Cabinetmaking Set
A \$9.90 VALUE
Yours for only \$4.90
DVD: DVDS1



Roundover Rail & Stile Set ITEM # 02011
Ogee Rail & Stile Set ITEM # 02012

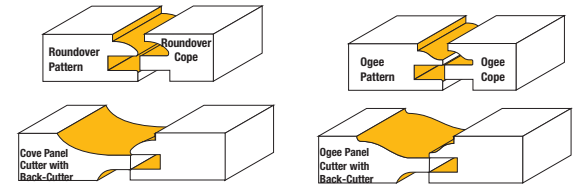

ITEM	Description	Bearing	Shank Diameter	Sale
01001	Shank Cove Raised Panel Cutter w/Back Cutter	HC318DZZ / 688ZZ	1/2"	\$89.90
01002	Shank Flush Trim Bit	R4AZZ	1/2"	\$32.90
01003	Shank Ogee Drawer Bit	R3ZZ	1/2"	\$50.90
01004	Shank Ogee Door Bit	R3ZZ	1/2"	\$50.90
02011	Shank Roundover Rail & Stile Bits (2 Bit Pair)	698ZZ / 608ZZ	1/2"	\$99.90
06001	6-Pc Cove Cabinetmaking Set			\$259.90
01015	Shank Ogee Raised Panel Cutter w/Back Cutter	HC318DZZ / 688ZZ	1/2"	\$89.90
01002	Shank Flush Trim Bit	R4AZZ	1/2"	\$32.90
01003	Shank Ogee Drawer Bit	R3ZZ	1/2"	\$50.90
01004	Shank Ogee Door Bit	R3ZZ	1/2"	\$50.90
02012	Shank Ogee Rail & Stile Bits (2 Bit Pair)	698ZZ / 608ZZ	1/2"	\$99.90
06008	6-Pc Ogee Cabinetmaking Set			\$259.90

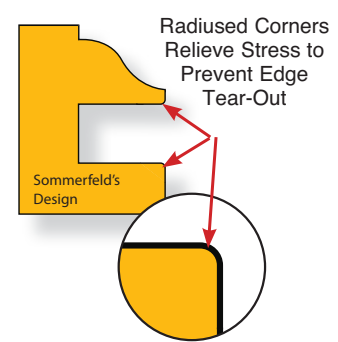

3-Pc Shaker Set

Create simple, attractive looking 22-1/2 degree beveled raised panels for mission or Shaker style furniture and cabinets

- All 3 bits are perfectly matched in cutting height for fast, no-hassle set-ups
- Stile and rail cutters have a 7/16" engagement
- The panel cutter is preset to fit in the 7/32" groove in the stiles and rails
- Machines material from 3/4" to 7/8" thick
- The groove for the stile and rail is set for 7/32" for many of the undersize plywoods.
- There is an optional 1/4" groove cutter that can be interchanged with the pattern cutter for regular 1/4" thick plywood. **IMPORTANT:** You will also have to shim the cope cutting bit and raised panel bit with a 1/32" shim making them 1/4" to allow for perfect fit.

HALF-PRICE



**HOW-TO DVD
With Purchase Of
The Shaker Set
A \$9.90 VALUE
Yours for only \$4.⁹⁰
DVD: DVDS5**



Box has flush-mounted magnetic catch.

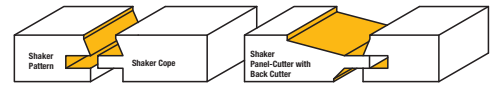

ITEM	Description	Bearing	Shank Diameter	Sale
01005	Shank Shaker Raised Panel Cutter w/Back-Cutter	688ZZ	1/2"	\$89.90
02002	Shank Shaker Rail & Stile Bits (2 Bit Pair)	608ZZ	1/2"	\$99.90
SM82442BL-2	1/4" Groove Cutter (Sold separately)	-	-	\$19.90
03005	3-Pc Shaker Set			\$149.90

3-Pc Shaker Glass Panel Door Set

Clean, Simple Shaker Style Glass Doors can now be made quickly and easily!

- All 3 bits are perfectly matched in cutting height for fast, no-hassle set-ups
- Rail & Stile Cutter provide a square rabbet on the underside of the frame for installing 1/8" Double strength glass
- Machines material from 3/4" to 7/8" thick

HALF-PRICE

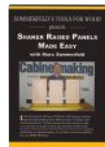

**HOW-TO DVD
With Purchase Of
The Shaker Glass Set
A \$9.90 VALUE
Yours for only \$4.⁹⁰
DVD: DVDS2**



Box has flush-mounted magnetic catch.

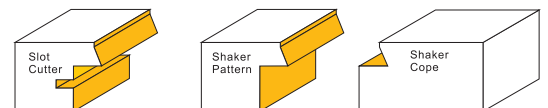

ITEM	Description	Shank Diameter	Bearing	Sale
01017S	1/2" Shank Slot Cutter, 2-1/16" Dia.	1/2"	SRI1212ZZ	\$39.90
02007S	1/2" Shank Rail & Stile Bits (2 Bit Pair)	1/2"	608ZZ	\$99.90
03007	3-Pc Shaker Glass Panel Set			\$139.90

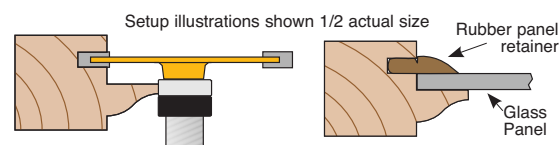

The slot cutter cuts a slot for the rubber panel retainer

**All Glass Panel Door Sets
Are Designed to be used
with Rubber Glass Panel
Retainers**

ITEM# GLASS
25' Roll Brown Rubber
Glass Panel Retainer
SALE: \$14.⁹⁰



3-Pc Roundover Glass Panel Door Set

Build any type of glass panel door quickly and easily. Choose from straight, arched or divided light doors with muttons & mullions. This set makes them all fit perfectly!

- All 3 bits are perfectly matched in cutting height for fast, no-hassle set-ups
- Rail & Stile Cutter provide a square rabbet on the underside of the frame for installing **1/8" Double strength glass**
- Machines material from 3/4" to 7/8" thick

ITEM# GLASSW
25' Roll Clear Rubber
Glass Panel Retainer

SALE: \$14.⁹⁰



YouTube

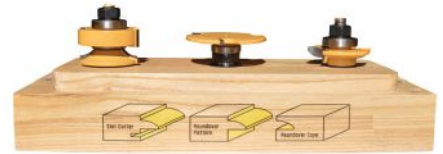

HALF-PRICE



HOW-TO DVD
With Purchase Of The
Roundover Glass Set

A \$9.90 VALUE

Yours for only \$4.⁹⁰

DVD: DVDS2

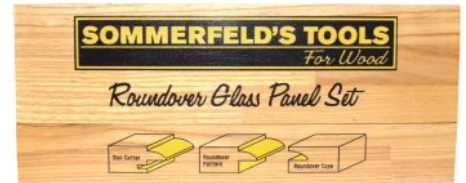

Box has flush-mounted magnetic catch.

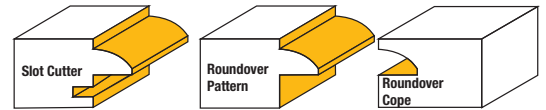

ITEM	Description	Bearing	Shank Diameter	Sale
01017	1/2" Shank Slot Cutter, 2-1/16" Dia.	SRI1212ZZ	1/2"	\$39.90
02007R	1/2" Shank Rail & Stile Bits (2 Bit Pair)	SRI1212ZZ	1/2"	\$99.90
03011	3-Pc Roundover Glass Panel Door Set			\$139.90

3-Pc Ogee Glass Panel Door Set

Build any type of glass panel door quickly and easily. Choose from straight, arched or divided light doors with muttons & mullions. This set makes them all fit perfectly!

- All 3 bits are perfectly matched in cutting height for fast, no-hassle set-ups
- Rail & Stile Cutter provide a square rabbet on the underside of the frame for installing **1/8" Double strength glass**
- Machines material from 3/4" to 7/8" thick

YouTube



HALF-PRICE



HOW-TO DVD
With Purchase Of The
Ogee Glass Set

A \$9.90 VALUE

Yours for only \$4.⁹⁰

DVD: DVDS2

Box has flush-mounted magnetic catch.

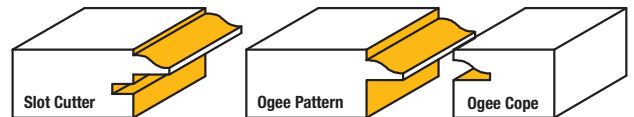

ITEM	Description	Bearing	Shank Diameter	Sale
01017	1/2" Shank Slot Cutter, 2-1/16" Dia.	SRI1212ZZ	1/2"	\$39.90
02007	1/2" Shank Rail & Stile Bits (2 Bit Pair)	SRI1212ZZ	1/2"	\$99.90
03003	3-Pc Ogee Glass Panel Door Set			\$139.90



Sommerfeld's Angle Making Set



Add a whole new dimension to your cabinetry by creating angular mid-sections and radiused corner treatments.

Curves and angles add eye-catching excitement to traditional cabinetry designs. With this set you can create tight curves by using narrow strips of wood or wider, more gradual curves with wider flat sections.

Radiused corners on kitchen islands are just one example everyone can relate to. The possibilities are endless with Sommerfeld's Angle Making Set.

HALF-PRICE



HOW-TO DVD
With Purchase Of The
Anglemaking Set
A \$9.90 VALUE

Yours for only \$4.90
DVD: DVDS9

Box has flush-mounted magnetic catch.

Set includes four matched pairs of bits for 11.25°, 15°, 22.5° and 30° angle making



Here are some examples of different corner treatments that can be created with the Sommerfeld Angle Making Set.

You can also incorporate fluting into your designs to create additional interest.



In addition to radiused corners you can also incorporate angular mid-sections to offset particular areas of cabinets and add exciting new dimensions to your cabinetry designs.

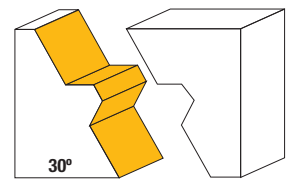
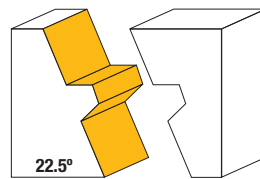
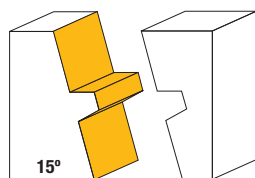
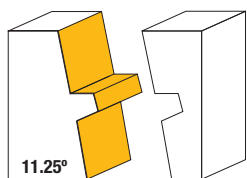

ITEM	Description	Shank Diameter	Sale
08002	Sommerfeld's Angle Making Set	1/2"	\$219.90



Sommerfeld's Revolutionary Beaded Face Frame System



Only Sommerfeld's Beaded Face Frame System allows you to create beautiful beaded face frames easily and affordably using a table saw and router table

Order Fence & Face Frame **SAVE \$27.98**
Get 01020B & 01020 For Just **\$251.82**
Item #01020COMBO

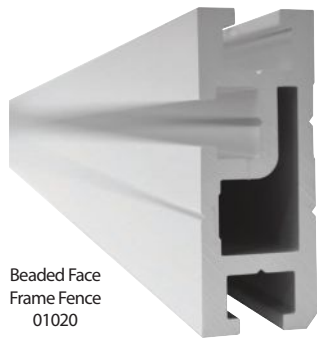

Beaded Face Frame Fence 01020



HOW-TO DVD
DVD Included with System
A \$9.90 VALUE
DVD: DVD10



STEP 1: Cut notches in the face frames



STEP 2: Cut chamfers to fit into the notches

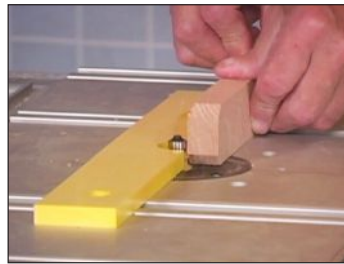

STEP 3: Route the bead on the face frames for decorative purposes



STEP 4: Use Sommerfeld's 3-in-1 Pocket Cutter or pin the frame together

- 6 tooth carbide-tipped groove cutter for tablesaw
- Includes 1/4" & 5/16" special beading bits to work with 1-1/2" & 1-5/8" wide face frames
- Great solution for cabinet shops
- Make beaded face frames in minutes
- Precision engineered & balanced
- Solid steel body on groove cutter head

Item #01020 Beaded Face Frame Fence Extrusion - The Track Extrusion is 48" long and acts as a fence to help push the stock through the cutter. (Can be used to make your own cross-cut sled) **Sold seperately**



The finished joint fits perfectly in only minutes!

Table Saw arbor must be at least 1-3/8" long.
Not made for small contractor saws.



01020B

ITEM	Description	Bearing	Shank Diameter	Sale
01020	Beaded Face Frame Fence Extrusion	R3ZZ	-	\$49.90
01020C	Beaded Bit 3/16" Diameter	R3ZZ	1/2"	\$22.90
01020D	Beaded Bit 1/4" Diameter	R3ZZ	1/2"	\$23.90
01020B	Beaded Face Frame System			\$229.90

6-Pc Jointmaking Set

The set to reach for when you need quick, super-strong special-purpose joints for your important, strength-critical projects



Add our Easy Set Jig (see Page 50) for precise set-ups and fast changeover times!

Here it is – the best collection of jointmaking bits we have. Some woodworkers have shied away from using these difficult to set-up bits because none of them have a bearing for a cutting reference, and all six of them are difficult to set up to the correct height. Now these bits can be set up with ease with the help of the Easy Set (see page 50).

- ▶ The large lock miter bit produces perfectly-fitting miter joints that lock together in stock from 5/8" to 1 1/8".
- ▶ Also included is the baby lock miter that allows you to cut the same joints in stock from 3/8" to 3/4".
- ▶ 22-1/2° joints are very popular for angled kitchen cabinets, angled corner entertainment centers, kitchen islands, and corner hutches.
- ▶ Our two 22-1/2°-lock bits provide a fast, accurate, and strong way to build those angled joints. The two cutters are a matched pair in height for easy set-up.

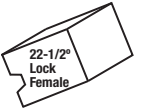
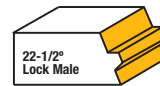
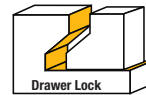

Box has flush-mounted magnetic catch.

Bit height set-up is a breeze with our Easy Set Jig
SEE PAGE 50

ITEM	Description	See Page	Shank Diameter	Sale
01009	Drawer Lock Bit	52	1/2"	\$52.90
01008	Reversible Glue Joint Bit	51	1/2"	\$52.90
01007	Baby Lock Miter Bit	51	1/2"	\$54.90
01006	Lock Miter Bit	51	1/2"	\$71.90
02004	22-1/2° Lock Miter Set (2 Bits)	50	1/2"	\$84.90
06002	6-Pc Jointmaking Set		1/2"	\$199.90



Box has flush-mounted magnetic catch.

▶ All of our bit sets are packaged in a beautiful, custom-designed hardwood case to keep your bits safe, clean and easy to find for many years of service.

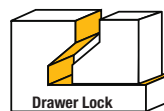

3-Pc Glue Joint Set

A value-priced starter for creating glue joints and drawer lock joints on stock up to 3/4" thick and 45 degree lock miter joints on stock from 3/4" to 1-1/8

Three of the most frequently used special-purpose joints in a single set

ITEM	Description	See Page	Shank Diameter	Sale
01009	Drawer Lock Bit	52	1/2"	\$52.90
01008	Reversible Glue Joint Bit	51	1/2"	\$52.90
01007	Baby Lock Miter Bit	51	1/2"	\$54.90
03006	3-Pc Glue Joint Set	-	1/2"	\$99.90

Special profile 4" Mitered Molding Bit

Turn 3" wide stock into an attractive molding profile for framing cabinet doors, furniture panels, picture frames and lots more

Before now you had to pay high, custom-tooling dollars to get this elegant look on a mitered raised panel. After you've made your first set of doors with your mitered molding bit, your work will be the admiration of all your woodworking friends.

- ▶ We advise using Sommerfeld's Tongue and Groove Cabinetmaking Set with this bit to make your mitered doors. For those of you that don't have our tongue and groove set, we have the pro set shown on page 11, which includes all 4 bits needed to create your mitered raised panel door.
- ▶ The center-point turning of all our bits ensures that this extra long bit (4") is perfectly balanced with no run out to produce professional quality cuts.
- ▶ We advise cutting 3" wide stiles and rails for building your mitered raised panel doors.
- ▶ Detailed instructions for making mitered raised panel doors included in the Mitered Raised Panels Made Easy DVD.

YouTube



HALF-PRICE



HOW-TO DVD
With Purchase Of The
Mitered Molding Bit

Mitered Raised Panels
Made Easy

A \$9.90 VALUE

Yours for only \$4.⁹⁰

DVD: DVDS7

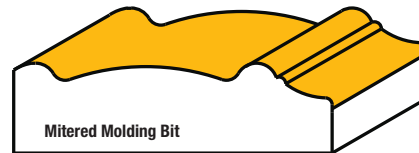

ITEM	Description	Bearing	Shank Diameter	Sale
01010SM	Small Mitered Molding Bit	R4ZZ	1/2"	\$56.90
01010	Mitered Molding Bit	R4ZZ	1/2"	\$89.90



Box has flush-mounted magnetic catch.

Sommerfeld's Leigh Jig Set

Sommerfeld's 13-piece dovetail and straight bit set contains all the most frequently-used bits for making boxes and creative joinery.

- ▶ The set comes with 1/4" and 1/2" shank bits and is designed to fit Leigh jig systems and also works with most other popular jigs. The set is packaged in a custom-designed hardwood case.

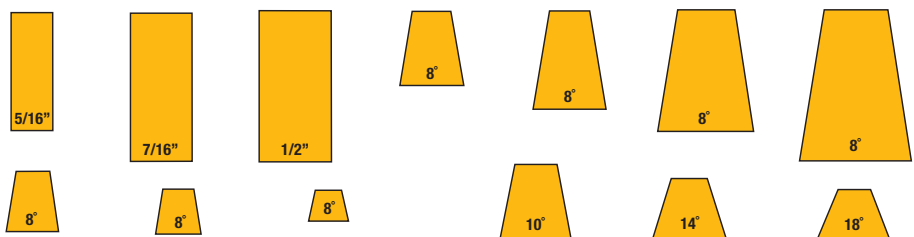

ITEM	Description	Shank Diameter	Sale
13001	Leigh Jig Set	1/4" & 1/2"	\$159.90



Sommerfeld's Revolutionary Cove Cutter for Curved Cabinetry

This curved cutter mounts in your table saw to create beautiful concaved curves in wood!

This cove cutter mounts on your table saw and is used with a pair of angled fences. You can create your own crown molding and any number of cove shapes and sizes simply by changing the two fence angles and adjusting the cutter height. See Marc's DVDS11 on Curved Cabinetry on how it works!

It's great for making inside corners or radiuses on cabinets! The cutter also works for making moldings for fine furniture and all kinds of casework. After the cut is machined, the surface needs just minimal sanding to produce a smooth finish!

Sommerfeld's Cove Cutter

- ✓ Set comes in nice carrying case
- ✓ Large Stabilizer washer included
- ✓ Fits all tablesaws
- ✓ 7" Diameter, 6 Carbide Teeth, 3/8" Radius
- ✓ Also Available - Curved Cabinets Made Easy DVD



Make curved cabinetry like a professional with the Sommerfeld's Cove Cutter!



When curves are joined with our 3-In-1 Pocket Cutter, (See page 8) you can create beautiful curved features!

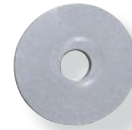

Large Stabilizer washer included

HALF-PRICE



HOW-TO DVD
With Purchase Of
The Cove Cutter

A \$9.90 VALUE

Yours for only \$4.⁹⁰

DVD: DVDS11

ITEM	Description	Sale
01021	Sommerfeld's Cove Cutter	\$129.90

Junior Raised Panel Set

Create miniature frames and panels for small jewelry boxes, gift boxes and similar projects with this scaled-down raised panel set

Machines material from 7/16"–11/16" thick, and as small as 2" square

- Frames and panels from material as thin as 7/16" to as thick as 11/16" to as small as 2" square.
- The raised panel cutter has a backcutter that accurately machines the tongue to 5/32" in one pass.
- The matching pair of stile and rail cutters produces tight-fitting joints for material from 7/16" to 11/16".
- Cove Raised Panel Bit with Backcutter has a 2-1/2" dia.

HALF-PRICE

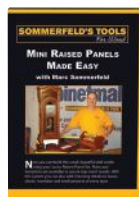

HOW-TO DVD
With Purchase Of
Junior Raised Panel Set

A \$9.90 VALUE

Yours for only \$4.⁹⁰

DVD: DVDS6



Box has flush-mounted magnetic catch.



ITEM	Description	Bearing	Shank Diameter	Sale
01018	Junior Raised Panel Cutter w/Back-Cutter	688ZZ	1/2"	\$79.90
02006	Miniature Rail & Stile Pattern/Cope (2 bits)	688ZZ	1/2"	\$79.90
03002	Junior Raised Panel Set		1/2"	\$119.90

5-Pc Chamfer Bit Set

Create beautiful chamfers from 11.25° to 45°

Our Chamfer Bits work great to make accurate bevels and chamfers for edge work or for making multi-sided boxes or decorative projects. Use this set to build perfectly aligned multi-sided pieces. These bits are in a handsome, lidded hardwood case.

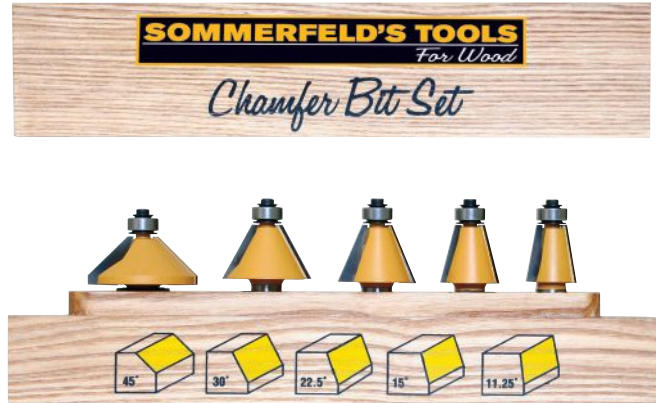
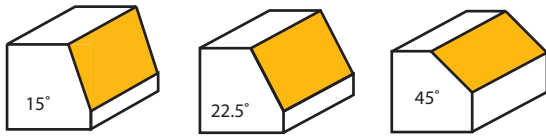

ITEM	Description	Degree	D Cutting Dia.	I Cutting Length	L Overall Length	S Shank Dia.	Bearing	Sale
512222B	Chamfer Bit	11.25°	7/8"	7/8"	2-7/8"	1/2"	R3ZZ	\$29.90
512542C	Chamfer Bit	15°	1"	7/8"	2-7/8"	1/2"	R3ZZ	\$25.90
513182B	Chamfer Bit	22.5°	1-1/4"	7/8"	2-7/8"	1/2"	R3ZZ	\$30.90
513812B	Chamfer Bit	30°	1-1/2"	7/8"	2-7/8"	1/2"	R3ZZ	\$33.90
514452	Chamfer Bit	45°	1-3/4"	29/32"	2-3/4"	1/2"	R3ZZ	\$38.90
05001	5-Pc Chamfer Bit Set	-	-	-	-	1/2"	-	\$139.90



Architectural Molding Set

Create your own custom moldings!

Don't pay the high prices for precut moldings. Save time and money and create your own by selecting the profile that's right for your job and use the type of wood you want. This set can create base and cabinet moldings, window casings, chair rails, door casings, panel moldings, picture frames, and more.

ITEM	Description	D Cutting Dia.	I Cutting Length	L Overall Length	S Shank Dia.	Bearing	Sale
862222B	Architectural Molding Bit	7/8"	1-5/8"	3-9/16"	1/2"	R3ZZ	\$40.90
862222C	Architectural Molding Bit	7/8"	1-5/8"	3-9/15"	1/2"	R3ZZ	\$41.90
862542D	Architectural Molding Bit	1"	1-3/8"	3-3/8"	1/2"	R3ZZ	\$42.90
862862E	Architectural Molding Bit	1-1/8"	1-5/8"	3-17/32"	1/2"	R3ZZ	\$43.90
862542K	Architectural Molding Bit	1"	1-5/8"	3-9/16"	1/2"	R3ZZ	\$46.90
863812I	Architectural Molding Bit	1-1/2"	1-1/2"	3-29/64"	1/2"	R3ZZ	\$57.90
864452H	Architectural Molding Bit	1-3/4"	1-1/8"	3-7/64"	1/2"	R3ZZ	\$47.90
07001	7-Pc Architectural Molding Set	-	-	-	1/2"	-	\$199.90

6-Pc Starter Set

A great all-around set for basic, general woodworking

This rugged, 1/2" shank, Starter Set includes six of our most popular bits in a protective hardwood case.

With this set, you'll be able to • Cut rabbets up to 3/8" deep x 1/2" high • Ease or round-over the edges of project components • Create cove (concave) workpiece edges • Form drop-leaf (rule) joints for table edges • Produce a decorative Roman Ogee edge • Chamfer workpiece edges to a 45° beveled angle • Cut round or flat-bottomed grooves in workpiece surfaces.

Set Includes: 1-1/4" diameter Rabbeting Bit • 3/8" Roundover Bit • 1/2" Cove Bit • 1/4" Roman Ogee Bit • 45° Chamfer Bit • 1/2" Roundnose Bit



Box has flush-mounted magnetic catch.

ITEM	Description	Cutting Radius / Angle	D Cutting Dia.	I Cutting Length	L Overall Length	S Shank Dia.	Bearing	Sale
071272	Round Nose Bit	1/4"	1/2"	1-1/4"	2-7/8"	1/2"		\$17.90
703182	Rabbeting Bit	3/8"	1-1/4"	1/2"	2-1/2"	1/2"	R3ZZ	\$21.90
623182	Roundover Bit	3/8"	1-1/4"	21/32"	2-11/16"	1/2"	R3ZZ	\$24.90
723812	Cove Bit	1/2"	1-1/2"	5/8"	2-11/16"	1/2"	R3ZZ	\$29.90
693812	Roman Ogee Bit	1/4"	1-1/2"	11/16"	2-3/4"	1/2"	R3ZZ	\$30.90
514452	Chamfer Bit	45°	1-3/4"	29/32"	2-7/8"	1/2"	R3ZZ	\$34.90
06004	6-Pc Starter Set	-	-	-	-	1/2"	-	\$99.90

12-Pc Introductory Set

Adds dovetailing, V-grooving, flush trimming and three sizes of straight bits to our Starter Set above for loads of extra work-saving convenience



ITEM	Description	Cutting Radius / Angle	D Cutting Dia.	I Cutting Length	L Overall Length	S Shank Dia.	Bearing	Sale
000632B	Straight Bit		1/4"	3/4"	2-1/2"	1/2"		\$11.90
001272C	Straight Bit		1/2"	1-1/4"	2-7/8"	1/2"		\$17.90
001902C	Straight Bit		3/4"	1-1/4"	2-7/8"	1/2"		\$23.90
051272	Dovetail Bit	14°	1/2"	1/2"	2-1/8"	1/2"		\$13.90
071272	Round Nose Bit	1/4"	1/2"	1-1/4"	2-7/8"	1/2"		\$17.90
501272A	Flush Trim Bit	1/2"	1/2"	2-1/2"	1/2"	1/2"	R3ZZ	\$13.90
081272	V-Groove Bit	90°	1/2"	1/2"	2-1/8"	1/2"		\$12.90
623812	Roundover Bit	1/2"	1-1/2"	3/4"	2-13/16"	1/2"	R3ZZ	\$28.90
723812	Cove Bit	1/2"	1-1/2"	5/8"	2-11/16"	1/2"	R3ZZ	\$29.90
513812	Chamfer Bit	45°	1-1/2"	23/32"	2-5/8"	1/2"	R3ZZ	\$26.90
703812	Rabbeting Bit		1-1/2"	1/2"	2-1/2"	1/2"	R3ZZ	\$27.90
693812	Roman Ogee Bit	1/4"	1-1/2"	11/16"	2-3/4"	1/2"	R3ZZ	\$30.90
12002	12-Pc Introductory Set	-	-	-	-	1/2"	-	\$169.90



4-Pc Roundover Bit Set

Top quality in one of today's most frequently used edging bit profiles

This four-piece Roundover Set is one of the most popular of all the sets we offer...and it's easy to see why. They're so versatile that you'll find yourself reaching for them again and again whenever you need to ease the edges of projects to create simple, smooth lines.

Or...use them in combination with our Cove Bit Set (see below) to help create the tight-fitting rule joints used for drop leaf tabletops.

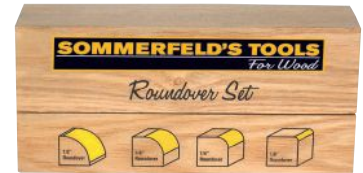
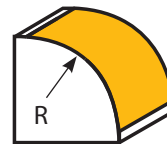
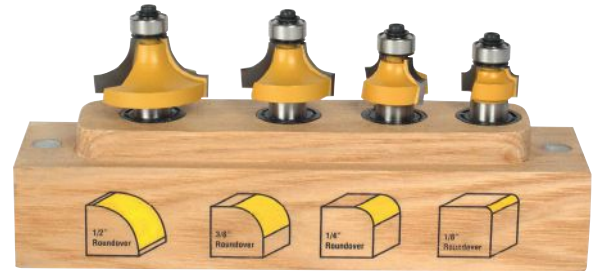

Order Both Sets
SAVE Another \$19.90!
Get 04002 & 04003 For Just
\$119.90
Item #20023

ITEM	Description	R Cutting Radius	D Cutting Dia.	I Cutting Length	L Overall Length	S Shank Dia.	Bearing	Sale
623812	Roundover Bit	1/2"	1-1/2"	3/4"	2-13/16"	1/2"	R3ZZ	\$28.90
623182	Roundover Bit	3/8"	1-1/4"	21/32"	2-11/16"	1/2"	R3ZZ	\$24.90
622542	Roundover Bit	1/4"	1"	17/32"	2-9/16"	1/2"	R3ZZ	\$20.90
621902	Roundover Bit	1/8"	3/4"	13/32"	2-1/2"	1/2"	R3ZZ	\$15.90
04002	4-Pc Roundover Bit Set	-	-	-	-	1/2"	-	\$69.90

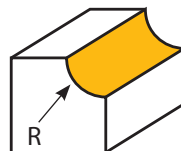
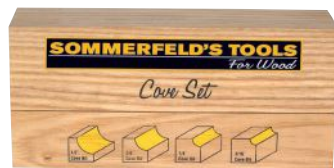
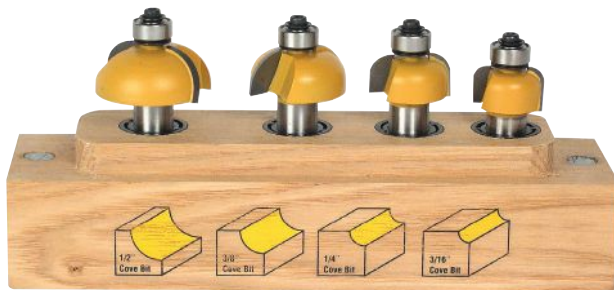

4-Pc Cove Bit Set

Here are the mirror image match-ups for our Roundover Bit Set above

The 4-piece Set is the perfect companion for our Roundover Set above. You'll use them to edge all types of furniture projects, cabinet doors, custom-designed picture frame moldings and lots more. Match them up with the corresponding Roundover Bit (see above) and they're perfect for creating the tight-fitting rule joints used for drop leaf tabletops.

ITEM	Description	R Cutting Radius	D Cutting Dia.	I Cutting Length	L Overall Length	S Shank Dia.	Bearing	Sale
723812	Cove Bit	1/2"	1-1/2"	5/8"	2-11/16"	1/2"	R3ZZ	\$29.90
723182	Cove Bit	3/8"	1-1/4"	9/16"	2-9/16"	1/2"	R3ZZ	\$24.90
722542	Cove Bit	1/4"	1"	1/2"	2-1/2"	1/2"	R3ZZ	\$19.90
722222	Cove Bit	3/16"	7/8"	1/2"	2-1/2"	1/2"	R3ZZ	\$18.90
04003	4-Pc Cove Bit Set	-	-	-	-	1/2"	-	\$69.90

6-Pc Plygroove / Flush-Trim Set

AT LAST! Straight dadoing/grooving router bits, sized to work with today's undersized plywoods – PLUS – three sizes of flush-trim bits

There's nothing worse than trying to connect one piece of plywood to another with dadoes or grooves that are 1/32" or more wider than the plywood that goes into them. This bit set solves that problem. It starts with three special, undersized Plygroove bits: 23/32", 31/64" and 7/32" – for use with 3/4", 1/2" & 1/4" plywood -- then adds three different sized flush-trim bits for working in tight spots as well as the wide, open spaces.

Set Includes one each: 1/4", 3/8" & 3/4" diameter bearing-piloted Flush-Trim Bits • 23/32", 31/64" & 7/32" diameter Plygroove Bits - all with 1/2" shanks



Box has flush-mounted magnetic catch.

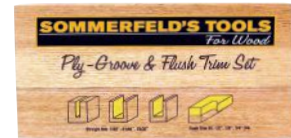

ITEM	Description	D Cutting Dia.	I Cutting Length	L Overall Length	S Shank Dia.	Bearing	Sale
000562B	Plygroove Bit	7/32"	3/4"	2-1/2"	1/2"		\$14.90
001232B	Plygroove Bit	31/64"	1"	2-1/2"	1/2"		\$17.90
001832B	Plygroove Bit	23/32"	1"	2-5/8"	1/2"		\$23.90
500632C	Flush Trim Bit	1/4"	1"	2-7/8"	1/2"	R144ZZ	\$14.90
500952B	Flush Trim Bit	3/8"	1"	3"	1/2"	R166ZZ	\$16.90
521902A	Flush Trim Bit	3/4"	1"	2-3/4"	1/2"	R4AZZ	\$22.90
06003	6-Pc Plygroove / Flush Trim Set	-	-	-	1/2"	-	\$69.90

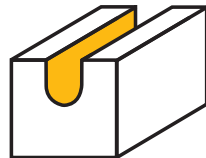
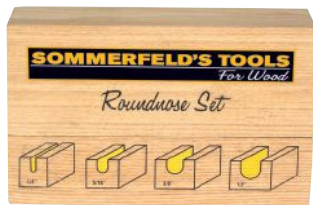
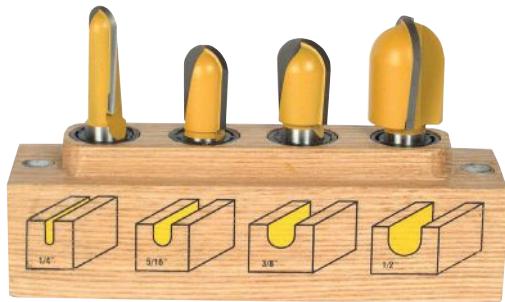
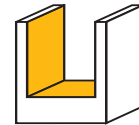

4-Pc Roundnose Set

An inexpensive, must-have bit set for engraving workpiece surface designs, signmaking or fluting furniture legs and moldings

This simple, 4-Pc set is a favorite of professional signmakers and cabinetmakers alike. Used by signmakers for engraving lettering, logos and designs into the surfaces of wood and similar materials, while cabinetmakers use them for fluting and making the stylish, custom decorative moldings and trim work that's common in today's cabinetry.

Set Includes one each:

1/4", 5/16", 3/8" and 1/2" radius.
Roundnose Bits - all with 1/2" shanks.

ITEM	Description	R Cutting Radius	D Cutting Dia.	I Cutting Length	L Overall Length	S Shank Dia.	Sale
071272	Roundnose Bit	1/4"	1/2"	1-1/4"	2-7/8"	1/2"	\$17.90
071582	Roundnose Bit	5/16"	5/8"	1"	2-1/2"	1/2"	\$19.90
071902B	Roundnose Bit	3/8"	3/4"	1"	2-5/8"	1/2"	\$22.90
072542	Roundnose Bit	1/2"	1"	1-1/4"	2-7/8"	1/2"	\$27.90
04004	4-Pc Roundnose Set	-	-	-	-	1/2"	\$69.90

12-Pc Mini Router Bit Set

Top quality in one of today's most frequently used edging bit profiles

Conventional router bits produce profiles that can overpower the delicate edges and surfaces of small gift or jewelry boxes and cabinets. So, Marc developed this set of twelve miniature bits to overcome that problem. We've received lots of comments about these little jewels ... most stating that they're ideal for adding fine, crisp details to box lids and edges, small picture frames, miniature furniture and similar projects.

Set Includes: 1/4" Core Box Bit • 35/64" Cove Bit • 3/8" Roundover Bit • 13/16" Roundover Bit • Classical plunge-type Ogee Bit • Ogee Panel Bit • Roman Ogee Bit • Ogee w/Fillet Bit • Classical Ogee Bit • 45° Chamfer Bit • Wavy Bit • Classical Bit - all with 1/4" shanks



Box has flush-mounted magnetic catch.

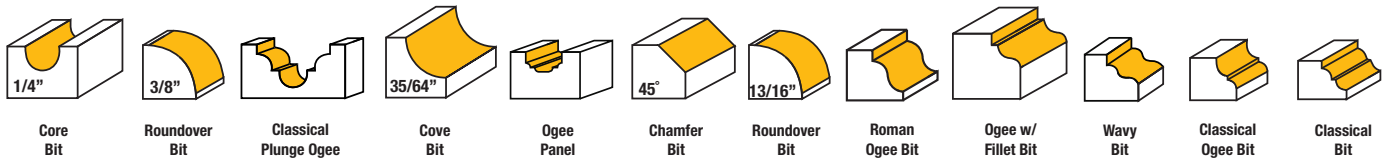

ITEM	Description	Bearing	Shank Diameter	Sale
12001	12-Pc Mini Router Bit Set	693ZZ	1/4"	\$99.90

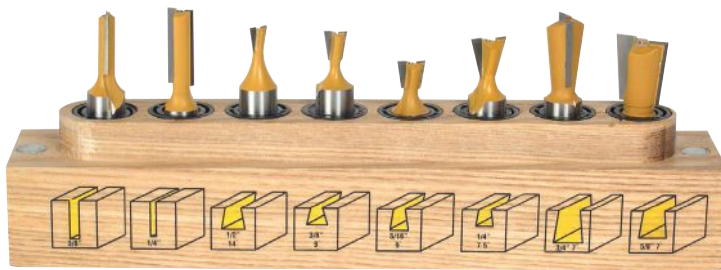

Set Includes: 3/8" Straight Bit • 1/4" Straight Bit • 3/4" - 7° Dovetail Bit • 5/8" - 7° Dovetail Bit • 1/2" - 14° Dovetail Bit • 3/8" - 9° Dovetail Bit • 5/16" - 9° Dovetail Bit • 1/4" - 7.5° Dovetail Bit - all with 1/2" shanks

8-Pc Inkra® / Jointech® Set

Sommerfeld's set of straight and dovetail router bits for use with the positioning systems manufactured by these two recognized companies

Here's a full set of bits, designed specifically for use with Inkra and Jointech products and accessories...all manufactured to our highest standards.

ITEM	Description	Cutting Radius / Angle	D Cutting Dia.	I Cutting Length	L Overall Length	S Shank Dia.	Sale
000632B	Straight Bit		1/4"	3/4"	2-1/2"	1/2"	\$11.90
000952B	Straight Bit		3/8"	1"	2-3/4"	1/2"	\$12.90
050632	Dovetail Bit	7.5°	1/4"	5/16"	2-1/2"	1/2"	\$11.90
050792	Dovetail Bit	9°	5/16"	3/8"	2-1/2"	1/2"	\$11.90
050952	Dovetail Bit	9°	3/8"	3/8"	2-1/8"	1/2"	\$12.90
051272	Dovetail Bit	14°	1/2"	1/2"	2-1/8"	1/2"	\$13.90
051582	Dovetail Bit	7°	5/8"	7/8"	2-1/8"	1/2"	\$16.90
051902	Dovetail Bit	7°	3/4"	7/8"	2-1/8"	1/2"	\$18.90
08001	8-Pc Inkra/ Jointech Set	-	-	-	-	-	\$79.90

Straight Bits - Two Flutes

Great for any project!

Sommerfeld's Straight Bits are the perfect choice: razor-sharp, double-fluted tools with all of the features and advantages that define quality Sommerfeld products.

Made of special high-strength steel, our straight bits can withstand even the heaviest work load and still give you a smooth, precise cut every time. They also provide exceptional chip ejection to allow cleaner and more constant cutting.

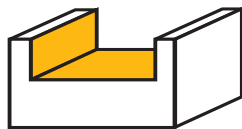
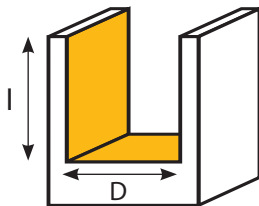

Mix 'N Match
on **ALL**
Individual Bits!

Buy 2 SAVE 10%
Buy 3 SAVE 15%
Buy 4+ SAVE 20%

ITEM	D Cutting Diameter	I Cutting Length	L Overall Length	S Shank Diameter	Sale
000631A	1/4"	5/8"	1-7/8"	1/4"	\$11.90
000631B	1/4"	3/4"	2"	1/4"	\$11.90
000631C	1/4"	1"	2-1/4"	1/4"	\$11.90
000791A	5/16"	3/4"	2"	1/4"	\$11.90
000791B	5/16"	1"	2-1/4"	1/4"	\$12.90
000791C	5/16"	1-1/4"	2-1/2"	1/4"	\$13.90
000951A	3/8"	3/4"	2"	1/4"	\$11.90
000951B	3/8"	1"	2-1/4"	1/4"	\$12.90
000951C	3/8"	1-1/4"	2-1/2"	1/4"	\$13.90
001271A	1/2"	3/4"	2"	1/4"	\$12.90
001271B	1/2"	1"	2-1/4"	1/4"	\$15.90
001271C	1/2"	1-1/4"	2-1/2"	1/4"	\$17.90
001421A	9/16"	3/4"	2"	1/4"	\$14.90
001421B	9/16"	1"	2-1/4"	1/4"	\$16.90
001581A	5/8"	3/4"	2"	1/4"	\$15.90
001581B	5/8"	1"	2-1/4"	1/4"	\$16.90
001901A	3/4"	3/4"	2"	1/4"	\$17.90
001901B	3/4"	1"	2-1/4"	1/4"	\$20.90
000632A	1/4"	5/8"	2-1/4"	1/2"	\$11.90
000632B	1/4"	3/4"	2-1/2"	1/2"	\$11.90
000632C	1/4"	1"	2-5/8"	1/2"	\$11.90
000792A	5/16"	3/4"	2-1/2"	1/2"	\$12.90
000792B	5/16"	1"	2-3/4"	1/2"	\$12.90
000792C	5/16"	1-1/4"	2-3/4"	1/2"	\$14.90
000952A	3/8"	3/4"	2-1/2"	1/2"	\$12.90
000952B	3/8"	1"	2-3/4"	1/2"	\$12.90
000952C	3/8"	1-1/4"	2-3/4"	1/2"	\$13.90
001272B	1/2"	1"	2-5/8"	1/2"	\$15.90
001272C	1/2"	1-1/4"	2-7/8"	1/2"	\$17.90
001272E	1/2"	1-1/2"	3"	1/2"	\$19.90
001272L	1/2"	2-1/2"	4-1/2"	1/2"	\$28.90
001422B	9/16"	1"	2-5/8"	1/2"	\$16.90
001422C	9/16"	1-1/4"	2-7/8"	1/2"	\$18.90
001582B	5/8"	1"	2-5/8"	1/2"	\$16.90
001582C	5/8"	1-1/4"	2-7/8"	1/2"	\$18.90
001902B	3/4"	1"	2-5/8"	1/2"	\$20.90
001902C	3/4"	1-1/4"	2-7/8"	1/2"	\$23.90
001902E	3/4"	1-1/2"	3"	1/2"	\$27.90
002222A	7/8"	1"	2-5/8"	1/2"	\$21.90
002222B	7/8"	1-1/4"	2-7/8"	1/2"	\$23.90
002542A	1"	1"	2-5/8"	1/2"	\$25.90
002542B	1"	1-1/4"	2-7/8"	1/2"	\$26.90
002542C	1"	1-1/2"	3"	1/2"	\$31.90
003502B	1-3/8"	1-1/4"	2-7/8"	1/2"	\$32.90
004452B	1-3/4"	1-1/4"	2-7/8"	1/2"	\$42.90



Super Duty Straight Bits - Two Flutes

Sommerfeld's Straight Bits are the perfect choice: razor-sharp, double-fluted tools with all of the features and advantages that define quality Sommerfeld products.

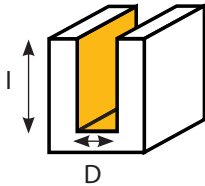

Mix 'N Match
on **ALL**
Individual Bits!

Buy 2 SAVE 10%
Buy 3 SAVE 15%
Buy 4+ SAVE 20%

ITEM	D Cutting Diameter	I Cutting Length	L Overall Length	S Shank Diameter	Sale
001272D	1/2"	2"	4"	1/2"	\$24.90
001422D	9/16"	2"	4"	1/2"	\$27.90
001582D	5/8"	2"	4"	1/2"	\$29.90

Straight Bits - Single Flutes

ITEM	D Cutting Diameter	I Cutting Length	L Overall Length	S Shank Diameter	Sale
S010321	1/8"	1/4"	2"	1/4"	\$17.90
S010401	5/32"	1/2"	2"	1/4"	\$17.90
010321	1/8"	1/2"	2"	1/4"	\$10.90
010471	3/16"	1/2"	1-7/8"	1/4"	\$10.90
010631	1/4"	3/4"	2"	1/4"	\$10.90
010951	3/8"	1"	2-1/4"	1/4"	\$11.90
010632	1/4"	3/4"	2-3/8"	1/2"	\$10.90
010952	3/8"	1"	2-1/2"	1/2"	\$11.90
011272	1/2"	1-1/4"	2-13/16"	1/2"	\$13.90

Sommerfeld's Straight Bits are the perfect choice: razor-sharp, single-fluted tools with all of the features and advantages that define quality Sommerfeld products.

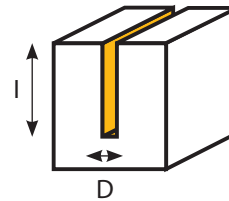

Stair Tread Bit

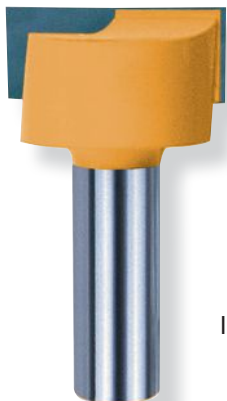

Sommerfeld's Stair Tread Bit is the perfect choice: razor-sharp, double-fluted tools with all of the features and advantages that define quality Sommerfeld products. Made of special high-strength steel, our straight bits can withstand even the heaviest work load and still give you a smooth, precise cut every time.

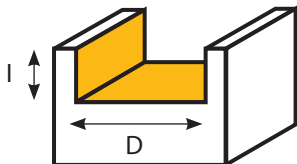

ITEM	D Cutting Diameter	I Cutting Length	L Overall Length	S Shank Diameter	Sale
ST3182	1-1/4"	15/32"	2-1/4"	1/2"	\$23.90

Solid Carbide Spiral Bits

Enjoy super-fast, super-smooth cuts and long-lasting durability

These industrial quality spiral bits combine effective chip removal with a continuous shearing action cut not obtained from our regular straight bits. The design allows for rapid chip removal and a chip breaker tip for plunging. Since the spiraled cutting edge always stays in contact with your stock, these bits will give you a smooth, chatter-free cut.

Do I use an upcut or downcut spiral bit?

Upcut spirals pull the chips toward the router. They are usually used for dadoing and mortising to obtain a smooth flat bottom. Ideal for mortise & tenon joints!

Downcut spirals push chips away from the router. They are usually used in laminate, veneer, or inlay work and produce a clean finished top surface.



SPU
Upcut

Solid Spiral Upcut Bits

ITEM	Cutting Diameter	Cutting Length	Overall Length	Shank	Sale
SPU1	1/8"	1/2"	2	1/4"	\$12.90
SPU2	5/32"	1/2"	2	1/4"	\$12.90
SPU3	3/16"	3/4"	2	1/4"	\$12.90
SPU4	1/4"	3/4"	2	1/4"	\$12.90
SPU5	1/4"	1	2-1/2"	1/4"	\$39.90
SPU6	5/16"	1	3	1/2"	\$39.90
SPU7	3/8"	1-1/4"	3	1/2"	\$39.90
SPU8	1/2"	1-1/4"	3	1/2"	\$39.90
SPU9	1/2"	1-1/2"	3-1/2"	1/2"	\$39.90
SPU10	1/2"	2	4	1/2"	\$39.90

Solid Spiral Downcut Bits

ITEM	Cutting Diameter	Cutting Length	Overall Length	Shank	Sale
SPD1	1/8"	1/2"	2	1/4"	\$12.90
SPD2	5/32"	1/2"	2	1/4"	\$12.90
SPD3	3/16"	3/4"	2	1/4"	\$12.90
SPD4	1/4"	3/4"	2	1/4"	\$12.90
SPD5	1/4"	1	2-1/2"	1/4"	\$39.90
SPD6	5/16"	1	3	1/2"	\$39.90
SPD7	3/8"	1-1/4"	3	1/2"	\$39.90
SPD8	1/2"	1-1/4"	3	1/2"	\$39.90
SPD9	1/2"	1-1/2"	3-1/2"	1/2"	\$39.90
SPD10	1/2"	2	4	1/2"	\$39.90



SPD
Downcut

Solid Carbide Straight Bits



Used to plane edges, cut grooves, rabbets, slots, or dadoes. Also can be used for mortising and carving applications, or where a flat bottom is required.

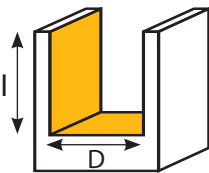

ITEM	D Cutting Diameter	I Cutting Length	L Overall Length	S Shank Diameter	Sale
S000321A	1/8"	3/8"	2"	1/4"	\$18.90
S000321B	1/8"	7/16"	2"	1/4"	\$18.90
S000321C	1/8"	1/2"	2-1/8"	1/4"	\$18.90
S000481A	3/16"	1/2"	2"	1/4"	\$18.90
S000481B	3/16"	3/4"	2-1/2"	1/4"	\$19.90

Solid Carbide Flush Trim Bits

A solid pilot eliminates the need for a ball bearing on those laminate trimmers.

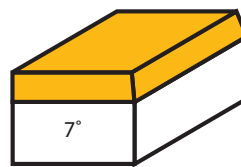
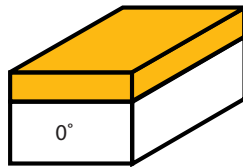

ITEM	Cutting Angle	D Cutting Diameter	I Cutting Length	L Overall Length	S Shank Diameter	Sale
140631A	0°	1/4"	1/4"	1-9/16"	1/4"	\$13.90
140631B	7°	1/4"	1/4"	1-9/16"	1/4"	\$13.90

Keyhole Bits

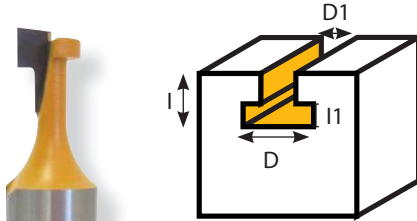

Cuts entry hole and slot for mounting pictures, plaques, clocks, or small cabinets. T-slot will accept the head of a screw or nail. Items will hang flush to the wall without additional hardware.

MARC'S TIP:

Route the slot horizontally. This will allow you to adjust the frame sideways until it is perfectly level.

ITEM	D Cutting Diameter	D1 Small Cutting Diam	I Cutting Length	I1 Cutting Edge Length	L Overall Length	S Shank Diameter	Sale
040951	3/8"	3/16"	7/16"	3/16"	1-7/8"	1/4"	\$11.90
041271	1/2"	1/4"	1/2"	3/16"	2"	1/4"	\$12.90
040952	3/8"	3/16"	7/16"	3/16"	2-23/64"	1/2"	\$12.90

Hinge Mortising Bits

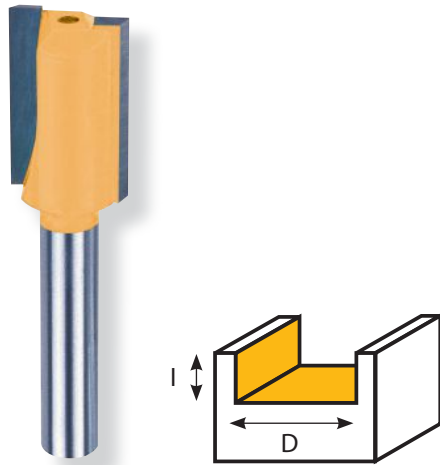

Used for mortising out hinges, locks, and stair treads. These modified straight bits ensure a perfectly flat bottom.

ITEM	D Cutting Diameter	I Cutting Length	L Overall Length	S Shank Diameter	Sale
091271A	1/2"	1/2"	1-3/4"	1/4"	\$13.90
091271B	1/2"	3/4"	2"	1/4"	\$13.90
091271C	1/2"	1"	2"	1/4"	\$15.90
091581	5/8"	3/4"	2"	1/4"	\$16.90
091901	3/4"	3/4"	2"	1/4"	\$17.90
091272B	1/2"	3/4"	2-3/8"	1/2"	\$13.90
091272C	1/2"	1"	2-3/8"	1/2"	\$15.90
091902	3/4"	3/4"	2-3/8"	1/2"	\$18.90
093182	1-1/4"	1/2"	2-1/8"	1/2"	\$23.90

Dish Cutter Bit

Perfect bits for creating the soft bottom edges of bowls, serving trays, plates and special boxes. Can also be used to make raised or recessed letters.

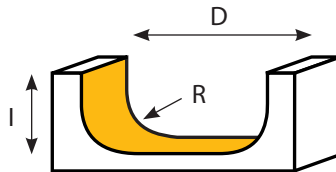

Mix 'N Match
on **ALL**
Individual Bits!

Buy 2 SAVE 10%
Buy 3 SAVE 15%
Buy 4+ SAVE 20%



ITEM	R Cutting Radius	D Cutting Diameter	I Cutting Length	L Overall Length	S Shank Diameter	Sale
162861D	1/4"	1-1/8"	1/2"	1-3/4"	1/4"	\$26.90

Groove & Bead Forming Bits

Great for sign making and creating a raised-panel look on solid doors.

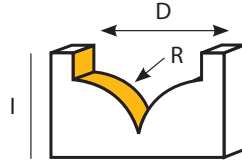

Mix 'N Match
on **ALL**
Individual Bits!

Buy 2 **SAVE 10%**
Buy 3 **SAVE 15%**
Buy 4+ **SAVE 20%**



ITEM	R Cutting Radius	D Cutting Diameter	I Cutting Length	L Overall Length	S Shank Diameter	Sale
160951C	5/32"	3/8"	5/16"	1-1/2"	1/4"	\$13.90
162222C	3/8"	7/8"	9/16"	2-3/32"	1/2"	\$20.90

V-Groove Bits

Will plunge cut a 90° V-groove. Used for cutting veins in door and drawer panels, chamfering edges, sign carving, and lettering. Also, you can order the bearing and stop collar for three of the bits for template routing.

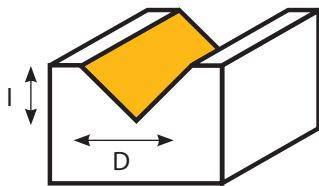

ITEM	Cutting Angle	D Cutting Diameter	I Cutting Length	L Overall Length	S Shank Diameter	Sale
080631	90°	1/4"	5/16"	1-9/16"	1/4"	\$11.90
080951*	90°	3/8"	1/2"	1-3/4"	1/4"	\$12.90
081271*	90°	1/2"	1/2"	1-3/4"	1/4"	\$12.90
081271B*	60°	1/2"	5/8"	1-7/8"	1/4"	\$12.90
081581	90°	5/8"	1/2"	1-3/4"	1/4"	\$13.90
081901	90°	3/4"	5/8"	1-7/8"	1/4"	\$15.90
083181	90°	1-1/4"	7/8"	2-1/8"	1/4"	\$30.90
080952	90°	3/8"	1/2"	2-1/8"	1/2"	\$12.90
081272	90°	1/2"	1/2"	2-1/8"	1/2"	\$12.90
081272B	60°	1/2"	5/8"	2-1/4"	1/2"	\$12.90
081582	90°	5/8"	1/2"	2-1/8"	1/2"	\$13.90
081902	90°	3/4"	5/8"	2-1/4"	1/2"	\$16.90
082542	90°	1"	3/4"	2-3/8"	1/2"	\$23.90
083182	90°	1-1/4"	7/8"	2-3/8"	1/2"	\$31.90

* Item number 080951, 081271 and 081271B use bearing number R188ZZ and stop collar LR1263505.

Classical Plunge Cut Bits

This bit is used to plunge into MAF or plywood to create a profile that will give the look of a raised panel door. Great for utility cabinets or painted doors!

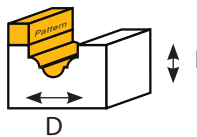

ITEM	R Cutting Radius	D Cutting Diameter	I Cutting Length	L Overall Length	S Shank Diameter	Sale
161271A	3/32"	1/2"	3/8"	1-21/32"	1/4"	\$13.90
161902A	5/32"	3/4"	1/2"	2"	1/2"	\$18.90
162542A	7/32"	1"	5/8"	2-1/8"	1/2"	\$22.90

Core Box Bits



These bits are used for fluting, veining, reeding, grooving or anywhere a round bottom is desired in all types of architectural millwork. Will plunge cut into softwoods, hardwoods, and composition materials.

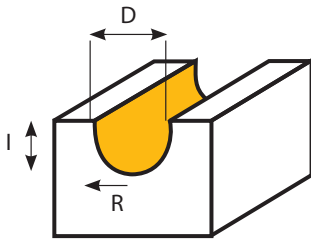

ITEM	R Cutting Radius	D Cutting Diameter	I Cutting Length	L Overall Length	S Shank Diameter	Sale
060631	1/8"	1/4"	1/4"	1-1/2"	1/4"	\$11.90
060951	3/16"	3/8"	3/8"	1-9/16"	1/4"	\$12.90
061271	1/4"	1/2"	3/8"	1-9/16"	1/4"	\$12.90
061581	5/16"	5/8"	1/2"	1-3/4"	1/4"	\$14.90
061901	3/8"	3/4"	1/2"	1-3/4"	1/4"	\$15.90
062541	1/2"	1"	5/8"	1-7/8"	1/4"	\$21.90
060952	3/16"	3/8"	3/8"	2"	1/2"	\$11.90
061272	1/4"	1/2"	3/8"	2"	1/2"	\$12.90
061582	5/16"	5/8"	1/2"	2-1/8"	1/2"	\$14.90
061902	3/8"	3/4"	1/2"	2-1/8"	1/2"	\$15.90
062542	1/2"	1"	5/8"	2-1/4"	1/2"	\$22.90
063182	5/8"	1-1/4"	3/4"	2-3/8"	1/2"	\$30.90
063492	11/16"	1-3/8"	7/8"	2-1/2"	1/2"	\$30.90
063812	3/4"	1-1/2"	7/8"	2-7/8"	1/2"	\$31.90
064452	7/8"	1-3/4"	1"	2-5/8"	1/2"	\$39.90
065082	1"	2"	1-1/8"	3-1/8"	1/2"	\$44.90

Roundnose Bits

ITEM	R Cutting Radius	D Cutting Diameter	I Cutting Length	L Overall Length	S Shank Diameter	Sale
070321	1/16"	1/8"	5/16"	1-13/16"	1/4"	\$11.90
070631	1/8"	1/4"	1/2"	1-3/4"	1/4"	\$11.90
070951	3/16"	3/8"	1/2"	1-3/4"	1/4"	\$12.90
071271	1/4"	1/2"	1"	2-1/4"	1/4"	\$15.90
071581	5/16"	5/8"	5/8"	1-7/8"	1/4"	\$16.90
071272	1/4"	1/2"	1-1/4"	2-7/8"	1/2"	\$17.90
071582	5/16"	5/8"	1"	2-1/2"	1/2"	\$19.90
071902	3/8"	3/4"	1-1/4"	2-7/8"	1/2"	\$23.90
071902B	3/8"	3/4"	1"	2-5/8"	1/2"	\$22.90
072542	1/2"	1"	1-1/4"	2-7/8"	1/2"	\$27.90

These bits are used for fluting, veining, reeding, grooving or anywhere a round bottom is desired in all types of architectural millwork. Will plunge cut into softwoods, hardwoods, and composition materials.

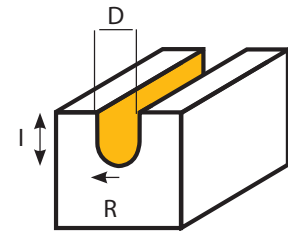

Panel Pilot Bits

Great for cutting openings in paneling, drywall or siding as well as for trimming formica, veneer and other laminates.

SAFETY TIP:

Always disconnect electricity when working near electrical outlets and boxes. Be careful that the bit does not go so deep as to cut the wires.



ITEM	D Cutting Diameter	I Cutting Length	L Overall Length	S Shank Diameter	Sale
030631	1/4"	3/4"	2-9/16"	1/4"	\$12.90
030951	3/8"	1"	3"	1/4"	\$13.90
031272	1/2"	1-1/8"	3-9/16"	1/2"	\$15.90

Dovetail Bits

Our dovetail bits are designed with high radial relief angles to give you extra-clean, sharp edges. Dovetail bits cut strong, as well as decorative, joints. Used on drawers, boxes, and furniture caseworks.

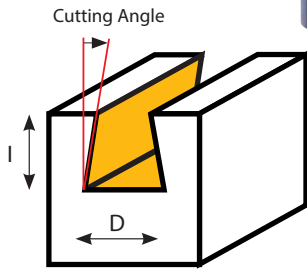

ITEM	Cutting Angle	D Cutting Diameter	I Cutting Length	L Overall Length	S Shank Diameter	Sale
01011	7°	7/16"	3/4"	2-5/8"	1/4"	\$19.90
01011C	7°	7/16"	1"	2-5/8"	1/4"	\$19.90
050631	7.5°	1/4"	5/16"	2-1/2"	1/4"	\$11.90
050791	9°	5/16"	3/8"	2-1/2"	1/4"	\$12.90
050951	9°	3/8"	3/8"	1-9/16"	1/4"	\$11.90
051271	14°	1/2"	1/2"	1-3/4"	1/4"	\$12.90
051581	7°	5/8"	7/8"	2-1/8"	1/4"	\$16.90
051901	7°	3/4"	7/8"	2-1/8"	1/4"	\$18.90
051901B	14°	3/4"	3/4"	2-1/8"	1/4"	\$16.90
050632	7.5°	15/64"	5/16"	2-1/2"	1/2"	\$11.90
050792	9°	9/32"	3/8"	2-1/2"	1/2"	\$12.90
050952	9°	3/8"	3/8"	2-1/8"	1/2"	\$12.90
051272	14°	1/2"	1/2"	2-1/8"	1/2"	\$13.90
051582	7°	5/8"	7/8"	2-1/2"	1/2"	\$16.90
051902	7°	3/4"	7/8"	2-1/2"	1/2"	\$18.90
051902B	14°	3/4"	3/4"	2-1/2"	1/2"	\$17.90
052542	14°	1"	7/8"	2-1/2"	1/2"	\$23.90

Ovolo Bits

Sometimes referred to as a plunging roundover bit, this is the ideal bit to be used in furniture making. Used to cut grooves, veins, roundovers, or beaded edges. These bits should be used with a guide or router table fence.

ITEM	R Cutting Radius	D Cutting Diameter	I Cutting Length	L Overall Length	S Shank Diameter	Sale
101901	1/8"	3/4"	7/16"	1-11/16"	1/4"	\$14.90
102541	1/4"	1"	9/16"	1-13/16"	1/4"	\$19.90
103181	3/8"	1-1/4"	5/8"	1-7/8"	1/4"	\$22.90
103811	1/2"	1-1/2"	3/4"	2"	1/4"	\$26.90
101902	1/8"	3/4"	7/16"	2-1/8"	1/2"	\$14.90
102542	1/4"	1"	9/16"	2-1/4"	1/2"	\$19.90
103182	3/8"	1-1/4"	5/8"	2-1/4"	1/2"	\$23.90
103812	1/2"	1-1/2"	3/4"	2-3/8"	1/2"	\$27.90
105082	3/4"	2"	1"	2-1/2"	1/2"	\$46.90
105712	7/8"	2-1/4"	1-1/8"	2-5/8"	1/2"	\$51.90
106352	1"	2-1/2"	1-1/4"	2-7/8"	1/2"	\$56.90

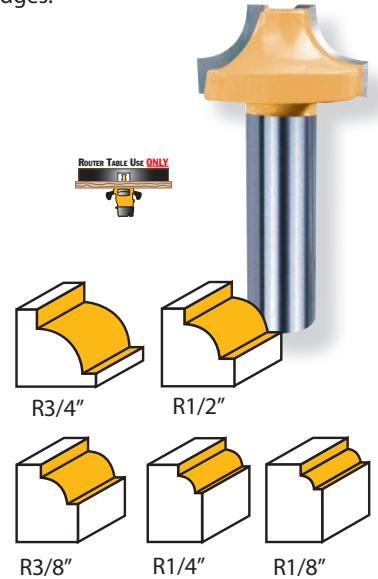

Combination Trimmer Bits



Used to cut, trim or bevel any surface without having to change bits; just change bit height. Comes in 3 different cutting angles. Must be used with router table fence or straight edge.

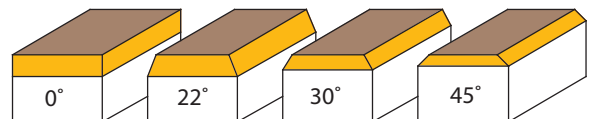

ITEM	Cutting Angle	D Cutting Diameter	I Cutting Length	L Overall Length	S Shank Diameter	Sale
111111	0° - 22°	7/16"	7/16"	1-7/8"	1/4"	\$11.90
111191A	0° - 22°	15/32"	1/2"	1-7/8"	1/4"	\$11.90
111191B	0° - 30°	15/32"	1/2"	1-7/8"	1/4"	\$11.90
111191C	0° - 45°	15/32"	1/2"	1-7/8"	1/4"	\$11.90

Full Bead Bit

Accent round or square legs and moldings. Makes an attractive bead on beams and post railings. Comes with two bearings as shown.

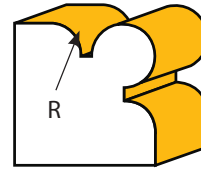

ITEM	R Cutting Radius	D Cutting Diameter	I Cutting Length	L Overall Length	S Shank Diameter	Bearing	Sale
402541C	1/8"	7/8"	1/2"	2-1/4"	1/4"	R4ZZ	\$27.90

Adjustable Roundover Bit

One of the most-used bits designed for decorative edges. Add a smaller bearing to make a beading bit. Lower the depth of the bit to produce a bead on top. Use to make a drop-leaf table when using our cove bits with the same radius.

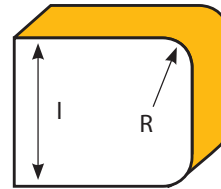

ITEM	R Cutting Radius	D Cutting Diameter	I Cutting Length	L Overall Length	S Shank Diameter	Bearing	Sale
613492A	1/4"	3/16"	1-3/8"	4-1/8"	1/2"	608ZZ	\$61.90



Flute & Bead Bits

Build your own canoes, hot tubs, or other curved shapes with this Flute & Bead Bit.

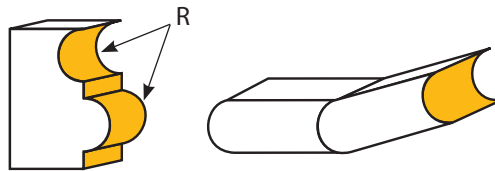

ITEM	R Cutting Radius	D Cutting Diameter	I Cutting Length	L Overall Length	S Shank Diameter	Bearing	Sale
402541E	1/8"	1"	5/8"	2-3/8"	1/4"	R3ZZ	\$25.90
402542E	1/8"	1"	5/8"	2-9/16"	1/2"	R3ZZ	\$25.90



Plunging Ogee Bits

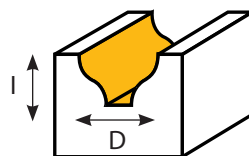

These bits are used to produce imitation raised panel doors. Bit is plunged into MDF or plywood to create a profile that will give the look of a raised-panel door. Great for utility cabinets or painted doors.

ITEM	R Cutting Radius	D Cutting Diameter	I Cutting Length	L Overall Length	S Shank Diameter	Sale
132381	3/16"	15/16"	5/8"	1-7/8"	1/4"	\$18.90
132382	3/16"	15/16"	5/8"	2-3/8"	1/2"	\$19.90
133131	1/4"	1-15/64"	5/8"	1-7/8"	1/4"	\$24.90
133132	1/4"	1-15/64"	5/8"	2-3/8"	1/2"	\$26.90

Flush Trim Bits w/ Bearing



For use in trimming and pattern or template routing. Best used in router table where template is visible to bearing.

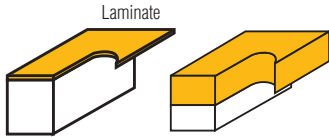
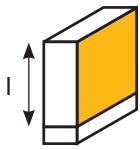

ITEM	D Cutting Diameter	I Cutting Length	L Overall Length	S Shank Diameter	B Bearing Diameter	Bearing	Sale
500631A	1/4"	1/2"	2-1/8"	1/4"	1/4"	R144ZZ	\$12.90
500631B	1/4"	3/4"	2-3/8"	1/4"	1/4"	R144ZZ	\$12.90
500631C	1/4"	1"	2-5/8"	1/4"	1/4"	R144ZZ	\$12.90
500791A	5/16"	1/2"	2-1/16"	1/4"	5/16"	R2-5ZZ	\$12.90
500791B	5/16"	1"	2-9/16"	1/4"	5/16"	R2-5ZZ	\$12.90
500791C	5/16"	1-1/4"	2-13/16"	1/4"	5/16"	R2-5ZZ	\$13.90
500951A	3/8"	1/2"	2-1/8"	1/4"	3/8"	R166ZZ	\$12.90
500951B	3/8"	1"	2-5/8"	1/4"	3/8"	R166ZZ	\$14.90
500951C	3/8"	1-1/4"	2-7/8"	1/4"	3/8"	R166ZZ	\$14.90
501271A	1/2"	1/2"	2-1/8"	1/4"	1/2"	R3ZZ	\$14.90
501271B	1/2"	1"	2-5/8"	1/4"	1/2"	R3ZZ	\$16.90
501271C	1/2"	1-1/4"	2-7/8"	1/4"	1/2"	R3ZZ	\$18.90
500632C	1/4"	1"	2-5/8"	1/2"	1/4"	R144ZZ	\$14.90
500952B	3/8"	1"	3"	1/2"	3/8"	R166ZZ	\$16.90
500952C	3/8"	1-1/4"	3-1/4"	1/2"	3/8"	R166ZZ	\$14.90
501272A	1/2"	1/2"	2-1/2"	1/2"	1/2"	R3ZZ	\$14.90
501272B	1/2"	1"	3"	1/2"	1/2"	R3ZZ	\$16.90
501272C	1/2"	1-1/4"	3-5/16"	1/2"	1/2"	R3ZZ	\$18.90
501272D	1/2"	1-1/2"	3-19/32"	1/2"	1/2"	R3ZZ	\$20.90
501272E	1/2"	2"	3-19/32"	1/2"	1/2"	R3ZZ	\$27.90

Super Duty Flush Trim Bits w/ Bearing

Down-shear flush trim bits eliminate tear out with less vibration. Creates smoother surface than a standard two-flute while giving better chip clearance.

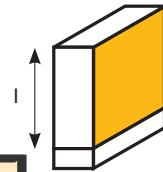

ITEM	D Cutting Diameter	I Cutting Length	L Overall Length	S Shank Diameter	B Bearing Diameter	Bearing	Sale
521901A	3/4"	1/2"	2-1/2"	1/4"	3/4"	R4AZZ	\$17.90
521901	3/4"	1"	2-1/2"	1/4"	3/4"	R4AZZ	\$20.90
521902A	3/4"	1"	2-3/4"	1/2"	3/4"	R4AZZ	\$20.90
521902B	3/4"	2"	4"	1/2"	3/4"	R4AZZ	\$30.90

3-Wing Flush Trim Bits

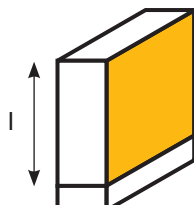

Down-shear flush trim bits eliminate tear out with less vibration. Creates smoother surfaces than a standard two-flute bit while giving better chip clearance.

ITEM	D Cutting Diameter	I Cutting Length	L Overall Length	S Shank Diameter	Bearing	Sale
501271A-3	1/2"	1/2"	2-1/4"	1/4"	R3ZZ	\$16.90
501271B-3	1/2"	1"	2-5/8"	1/4"	R3ZZ	\$18.90
501272B-3	1/2"	1"	3-1/8"	1/2"	R3ZZ	\$18.90
501272D-3	1/2"	1-1/2"	3-5/8"	1/2"	R3ZZ	\$24.90

Pattern Bits

2 Flute, carbide-tipped with totally enclosed ball bearing guides. Top-mounted bearing is ideal for template routing. Also ideal for flush trimming where a bottom-mounted bearing is not practical.

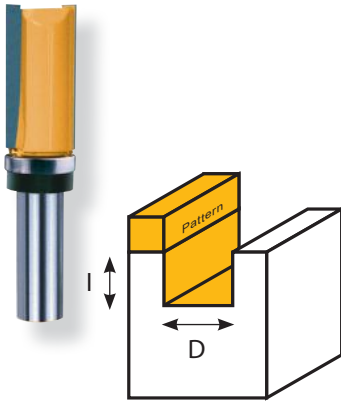

ITEM	D Cutting Diameter	I Cutting Length	L Overall Length	S Shank Diameter	B Bearing Diameter	Bearing	Sale
01012C	5/8"	1"	2-5/8"	1/4"	5/8"	R4ZZ	\$19.90
150631B	1/4"	3/4"	2-1/2"	1/4"	1/2"	R188ZZ	\$15.90
151271B	1/2"	1"	2-5/8"	1/4"	1/2"	R188ZZ	\$18.90
151581B	5/8"	1"	2-5/8"	1/4"	5/8"	R4ZZ	\$20.90
151901B	3/4"	1"	2-5/8"	1/4"	3/4"	R4AZZ	\$22.90
151902B	3/4"	1"	2-13/16"	1/2"	3/4"	SRI1212ZZ	\$23.90
151902E	3/4"	1-1/2"	3-5/16"	1/2"	3/4"	SRI1212ZZ	\$30.90
152862C	1-1/8"	1-1/2"	3-5/16"	1/2"	1-1/8"	HC286EZZ	\$38.90



Beveled Trimming Cutters

Trim and bevel almost any laminate or hard or soft wood.

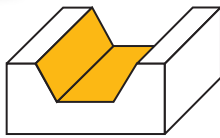

ITEM	R Cutting Angle	D Cutting Diameter	I Cutting Length	L Overall Length	S Shank Diameter	Sale
532001A	15°	25/32"	35/64"	1-1/2"	1/4"	\$17.90
532401A	30°	15/16"	1/2"	1-1/2"	1/4"	\$19.90
532401B	45°	15/16"	3/8"	1-3/8"	1/4"	\$18.90

Bevel Trim Bits

For extra-smooth trimming of laminates and other difficult materials.



ITEM	Cutting Angle	D Cutting Diameter	I Cutting Length	L Overall Length	S Shank Diameter	Bearing	Sale
511271A	7°	1/2"	3/8"	2-1/16"	1/4"	R3ZZ	\$17.90
511271B	22°	1/2"	3/8"	2-1/16"	1/4"	R3ZZ	\$19.90

Classical Plunge Cut - Top Bearing

These bits are used to produce imitation raised panel doors. Bit is plunged into MDF or plywood to create a profile that will give the look of a raised panel door. Great for utility cabinets or painted doors!

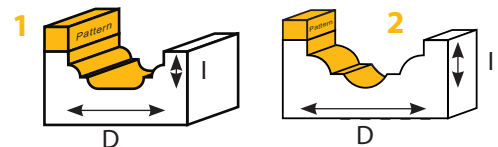

ITEM	R Cutting Radius	D Cutting Diameter	I Cutting Length	L Overall Length	S Shank Diameter	B Bearing Diameter	Bearing	Sale
172221B	1/8"	7/8"	1/2"	2-1/8"	1/4"	7/8"	HC222CZZ	\$26.90
173492B	7/32"	1-3/8"	5/8"	2-23/32"	1/2"	1-3/8"	HC349EZZ	\$33.90



Classical Plunge Cut - Top Bearing

ITEM	R1 Cutting Radius	R2 Cutting Radius	D Cutting Diameter	I Cutting Length	L Overall Length	S Shank Diameter	B Bearing Diameter	Bearing	Sale
173492M	1/4"	13/32"	1-3/8"	9/16"	2-5/8"	1/2"	1-3/8"	HC349EZZ	\$33.90

Bull Nose Bits



Bull Nose can produce finished edges of stair treads, table edges or windowsills. By selecting a smaller diameter bit, you can create a half-round bead. A larger diameter bit can make an elliptical curve on the edge. With two passes, it can also make dowels.

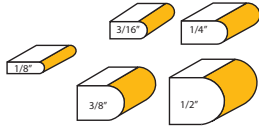

ITEM	R Cutting Radius	D Cutting Diameter	I Cutting Length	L Overall Length	S Shank Diameter	Sale
122221	1/8"	7/8"	3/4"	2"	1/4"	\$22.90
122541	3/16"	1"	7/8"	2-1/8"	1/4"	\$25.90
122861	1/4"	1-1/8"	1"	2-1/4"	1/4"	\$28.90
122222	1/8"	7/8"	3/4"	2-3/8"	1/2"	\$22.90
122542	3/16"	1"	7/8"	2-1/2"	1/2"	\$25.90
122862	1/4"	1-1/8"	1"	2-5/8"	1/2"	\$28.90
123492	3/8"	1-3/8"	1-3/8"	3"	1/2"	\$36.90
124452	1/2"	1-3/4"	1-5/8"	3-1/4"	1/2"	\$52.90
125082	5/8"	2"	1-3/4"	3-3/8"	1/2"	\$67.90

Bull Nose Half Radius Bits

These bits are used to soften edges on tables, countertops, stairs, and anywhere else a full radius bull nose is used.

ITEM	D Cutting Diameter	I Cutting Length	L Overall Length	S Shank Diameter	Sale
122061B	13/16"	1/4"	1-7/8"	1/4"	\$25.90
122541B	1"	3/4"	2-3/8"	1/4"	\$28.90
122542B	1"	7/8"	2-11/16"	1/2"	\$29.90
122862B	1-1/8"	1-1/4"	3"	1/2"	\$34.90

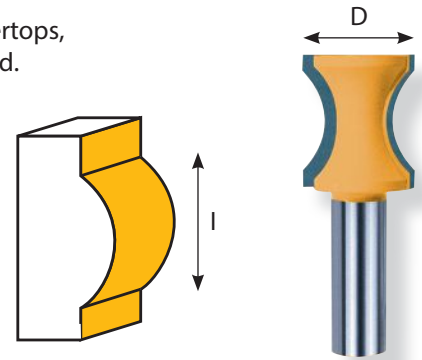

Bull Nose with Bearing Bits

Designed for many uses such as table legs and other furniture details. Can be used to match trim molding found in older homes. By rotating the stock, a full bead can be formed in 2 passes.

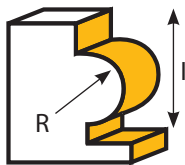

ITEM	R Cutting Radius	D Cutting Diameter	I Cutting Length	L Overall Length	S Shank Diameter	Bearing	Sale
401902B	1/8"	3/4"	5/8"	2-9/16"	1/2"	R3ZZ	\$19.90
402222B	3/16"	7/8"	1"	2-15/16"	1/2"	R3ZZ	\$25.90
402542B	1/4"	1"	1"	2-15/16"	1/2"	R3ZZ	\$27.90
403182B	3/8"	1-1/4"	1-1/4"	3-3/16"	1/2"	R3ZZ	\$35.90

Edge Beading Bits

Designed for many uses such as table legs and other furniture details. By rotating the stock, a full bead can be formed in 2 passes.

ITEM	R Cutting Radius	D Cutting Diameter	I Cutting Length	L Overall Length	S Shank Diameter	Bearing	Sale
402221	1/8"	7/8"	9/16"	2-7/32"	1/4"	R3ZZ	\$24.90
402541	3/16"	1"	11/16"	2-3/8"	1/4"	R3ZZ	\$25.90
402861	1/4"	1-1/8"	3/4"	2-7/16"	1/4"	R3ZZ	\$26.90
403492	3/8"	1-3/8"	1-1/8"	3-5/32"	1/2"	R3ZZ	\$34.90
404132	1/2"	1-5/8"	1-3/8"	3-25/64"	1/2"	R3ZZ	\$48.90
405402	3/4"	2-1/8"	2"	4"	1/2"	R3ZZ	\$63.90
402862	1/4"	1-1/8"	3/4"	2-11/16"	1/2"	R3ZZ	\$26.90

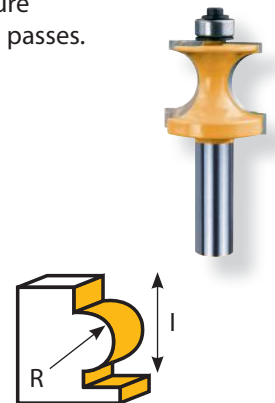

Roundover Bits with Bearing

One of the most-used bits designed for decorative edges. Lower the depth of the bit to produce a bead on top.

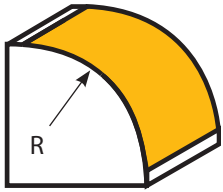

ITEM	R Cutting Radius	D Cutting Diameter	I Cutting Length	L Overall Length	S Shank Diameter	Bearing	Sale
621581	1/16"	5/8"	1/4"	1-7/8"	1/4"	R3ZZ	\$14.90
621901	1/8"	3/4"	13/32"	2-1/8"	1/4"	R3ZZ	\$15.90
622221	3/16"	7/8"	1/2"	2-3/16"	1/4"	R3ZZ	\$18.90
622541	1/4"	1"	17/32"	2-1/4"	1/4"	R3ZZ	\$19.90
622861	5/16"	1-1/8"	9/16"	2-1/4"	1/4"	R3ZZ	\$20.90
623181	3/8"	1-1/4"	21/32"	2-5/16"	1/4"	R3ZZ	\$23.90
623811	1/2"	1-1/2"	3/4"	2-7/16"	1/4"	R3ZZ	\$27.90
621582	1/16"	5/8"	1/4"	2-5/32"	1/2"	R3ZZ	\$14.90
621902	1/8"	3/4"	13/32"	2-5/16"	1/2"	R3ZZ	\$15.90
622222	3/16"	7/8"	1/2"	2-13/32"	1/2"	R3ZZ	\$18.90
622542	1/4"	1"	17/32"	2-17/32"	1/2"	R3ZZ	\$20.90
622862	5/16"	1-1/8"	9/16"	2-1/2"	1/2"	R3ZZ	\$21.90
623182	3/8"	1-1/4"	21/32"	2-11/16"	1/2"	R3ZZ	\$24.90
623812	1/2"	1-1/2"	3/4"	2-11/16"	1/2"	R3ZZ	\$28.90
624452	5/8"	1-3/4"	7/8"	2-7/8"	1/2"	R3ZZ	\$33.90
625082	3/4"	2"	1"	3"	1/2"	R3ZZ	\$40.90
625712	7/8"	2-1/4"	1-1/8"	3-1/8"	1/2"	R3ZZ	\$48.90
626352	1"	2-1/2"	1-1/4"	3-5/16"	1/2"	R3ZZ	\$57.90

Cove Bits with Bearing

Add an attractive edge to furniture, drawers, picture frames, or cabinet doors. Use anywhere you would use a roundover bit.



Use with our roundover bits of the same radius to make a drop-leaf table.

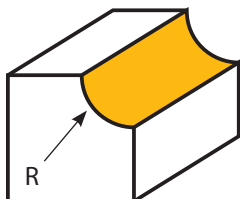

Mix 'N Match
on ALL
Individual Bits!

Buy 2 SAVE 10%
Buy 3 SAVE 15%
Buy 4+ SAVE 20%

ITEM	R Cutting Radius	D Cutting Diameter	I Cutting Length	L Overall Length	S Shank Diameter	Bearing	Sale
721901	1/8"	3/4"	3/8"	1-3/4"	1/4"	R3ZZ	\$16.90
722221	3/16"	7/8"	1/2"	2-3/16"	1/4"	R3ZZ	\$17.90
722541	1/4"	1"	1/2"	2-3/16"	1/4"	R3ZZ	\$18.90
722861	5/16"	1-1/8"	1/2"	2-3/16"	1/4"	R3ZZ	\$21.90
723181	3/8"	1-1/4"	9/16"	2-3/16"	1/4"	R3ZZ	\$23.90
723811	1/2"	1-1/2"	5/8"	2-5/16"	1/4"	R3ZZ	\$28.90
724451	5/8"	1-3/4"	3/4"	2-7/16"	1/4"	R3ZZ	\$37.90
722222	3/16"	7/8"	1/2"	2-3/8"	1/2"	R3ZZ	\$18.90
722542	1/4"	1"	1/2"	2-3/8"	1/2"	R3ZZ	\$19.90
722862	5/16"	1-1/8"	1/2"	2-3/8"	1/2"	R3ZZ	\$21.90
723182	3/8"	1-1/4"	9/16"	2-9/16"	1/2"	R3ZZ	\$24.90
723812	1/2"	1-1/2"	5/8"	2-9/16"	1/2"	R3ZZ	\$29.90
724452	5/8"	1-3/4"	3/4"	2-11/16"	1/2"	R3ZZ	\$37.90
725082	3/4"	2"	7/8"	2-7/8"	1/2"	R3ZZ	\$46.90
725712	7/8"	2-1/4"	1"	2-27/32"	1/2"	R3ZZ	\$53.90
726352	1"	2-1/2"	1-1/8"	3-1/32"	1/2"	R3ZZ	\$59.90

Beading Bits with Bearing

The beading bit is just a modification of the roundover bit with a smaller bearing on the bit, which provides a small step on the bottom edge. Use on drawer fronts, cabinet edges, and moldings. Used for Early American and period furniture.

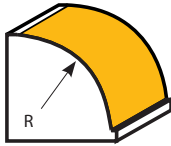

ITEM	R Cutting Radius	D Cutting Diameter	I Cutting Length	L Overall Length	S Shank Diameter	Bearing	Sale
631581	1/16"	5/8"	1/4"	1-7/8"	1/4"	R166ZZ	\$14.90
631901	1/8"	3/4"	13/32"	2-1/8"	1/4"	R166ZZ	\$15.90
632221	3/16"	7/8"	1/2"	2-3/16"	1/4"	R166ZZ	\$18.90
632541	1/4"	1"	17/32"	2-1/4"	1/4"	R166ZZ	\$19.90
632861	5/16"	1-1/8"	9/16"	2-1/4"	1/4"	R166ZZ	\$20.90
633181	3/8"	1-1/4"	21/32"	2-5/16"	1/4"	R166ZZ	\$23.90
633811	1/2"	1-1/2"	3/4"	2-7/16"	1/4"	R166ZZ	\$27.90
631582	1/16"	5/8"	1/4"	2-5/32"	1/2"	R166ZZ	\$14.90
631902	1/8"	3/4"	13/32"	2-5/16"	1/2"	R166ZZ	\$15.90
632222	3/16"	7/8"	1/2"	2-13/32"	1/2"	R166ZZ	\$18.90
632542	1/4"	1"	17/32"	2-17/32"	1/2"	R166ZZ	\$20.90
632862	5/16"	1-1/8"	9/16"	2-1/2"	1/2"	R166ZZ	\$21.90
633182	3/8"	1-1/4"	21/32"	2-11/16"	1/2"	R166ZZ	\$24.90
633812	1/2"	1-1/2"	3/4"	2-11/16"	1/2"	R166ZZ	\$28.90
634452	5/8"	1-3/4"	7/8"	2-7/8"	1/2"	R166ZZ	\$33.90
635082	3/4"	2"	1"	3"	1/2"	R166ZZ	\$47.90
635712	7/8"	2-1/4"	1-1/8"	3-1/8"	1/2"	R166ZZ	\$48.90
636352	1"	2-1/2"	1-1/4"	3-5/16"	1/2"	R166ZZ	\$56.90

Chamfer Bits with Bearing

Ideal for beveling and decorative edges. Used for producing mitered frames of different angles on planters, boxes, column, or beams.

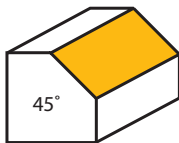
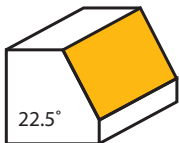
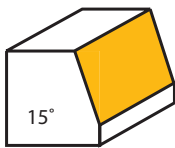
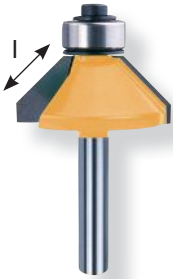

ITEM	Cutting Angle	D Cutting Diameter	I Cutting Length	L Overall Length	S Shank Diameter	Bearing	Sale
511581	15°	5/8"	1/4"	2-1/8"	1/4"	R3ZZ	\$15.90
511901	15°	3/4"	1/2"	2-3/16"	1/4"	R3ZZ	\$16.90
512221	25°	7/8"	1/2"	2-3/16"	1/4"	R3ZZ	\$16.90
513021	45°	1-3/16"	1/2"	2-1/8"	1/4"	R3ZZ	\$22.90
513181	45°	1-1/4"	17/32"	2-3/16"	1/4"	R3ZZ	\$23.90
513491	45°	1-3/8"	5/8"	2-5/16"	1/4"	R3ZZ	\$25.90
513811	45°	1-1/2"	23/32"	2-5/16"	1/4"	R3ZZ	\$26.90
514451	45°	1-3/4"	29/32"	2-7/16"	1/4"	R3ZZ	\$34.90
512541A	45°	1"	7/16"	2"	1/4"	R3ZZ	\$19.90
512541B	22.5°	1"	21/32"	2-1/4"	1/4"	R3ZZ	\$21.90
513181B	22.5°	1-1/4"	7/8"	2-9/16"	1/4"	R3ZZ	\$25.90
513022	45°	1-3/16"	1/2"	2-13/32"	1/2"	R3ZZ	\$22.90
513182	45°	1-1/4"	17/32"	2-7/16"	1/2"	R3ZZ	\$23.90
513492	45°	1-3/8"	5/8"	2-9/16"	1/2"	R3ZZ	\$25.90
513812	45°	1-1/2"	23/32"	2-9/16"	1/2"	R3ZZ	\$26.90
514452	45°	1-3/4"	29/32"	2-3/4"	1/2"	R3ZZ	\$38.90
515082	45°	2"	1-1/16"	2-13/16"	1/2"	R3ZZ	\$44.90
515712	45°	2-1/4"	1-1/4"	3-1/8"	1/2"	R3ZZ	\$52.90
512222B	11.25°	7/8"	7/8"	2-7/8"	1/2"	R3ZZ	\$29.90
512542C	15°	1"	7/8"	2-7/8"	1/2"	R3ZZ	\$25.90
513182B	22.5°	1-1/4"	7/8"	2-7/8"	1/2"	R3ZZ	\$30.90
513812B	30°	1-1/2"	7/8"	2-7/8"	1/2"	R3ZZ	\$33.90

Classical Bits with 1/2" Bearing

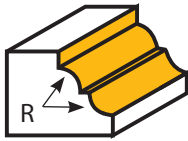

This bit is great for decorative edges on moldings, tables, mantels, picture frames, furniture, cabinet doors and much more!

ITEM	R Cutting Radius	D Cutting Diameter	I Cutting Length	L Overall Length	S Shank Diameter	Bearing	Sale
682861	1/8"	1-1/8"	1/2"	2-1/8"	1/4"	R3ZZ	\$24.90
682862	1/8"	1-1/8"	1/2"	2-1/2"	1/2"	R3ZZ	\$24.90
683331	5/32"	1-5/16"	1/2"	2-1/8"	1/4"	R3ZZ	\$25.90
683491	3/16"	1-3/8"	5/8"	2-5/16"	1/4"	R3ZZ	\$26.90
684281	1/4"	1-11/16"	3/4"	2-3/8"	1/4"	R3ZZ	\$34.90
683332	5/32"	1-5/16"	1/2"	2-5/8"	1/2"	R3ZZ	\$25.90
683492	3/16"	1-3/8"	5/8"	2-9/16"	1/2"	R3ZZ	\$26.90
684282	1/4"	1-11/16"	3/4"	2-3/4"	1/2"	R3ZZ	\$34.90

MARC'S TIP:

If you don't see a profile you need, try layering 2 or more different bits with multiple passes, especially on thicker stock.

Cove with Fillet Bits with 1/2" Bearing

This bit is great for decorative edges on moldings, tables, mantels, picture frames, furniture, cabinet doors and much more!

ITEM	R Cutting Radius	D Cutting Diameter	I Cutting Length	L Overall Length	S Shank Diameter	Bearing	Sale
732541	3/16"	1"	1/2"	2-3/16"	1/4"	R3ZZ	\$21.90
732861	1/4"	1-1/8"	17/32"	2-1/4"	1/4"	R3ZZ	\$22.90
733181	5/16"	1-1/4"	19/32"	2-1/4"	1/4"	R3ZZ	\$24.90
733491	3/8"	1-3/8"	21/32"	2-3/8"	1/4"	R3ZZ	\$27.90
732542	3/16"	1"	1/2"	2-13/32"	1/2"	R3ZZ	\$22.90
732862	1/4"	1-1/8"	17/32"	2-9/16"	1/2"	R3ZZ	\$23.90
733182	5/16"	1-1/4"	19/32"	2-5/8"	1/2"	R3ZZ	\$25.90
733492	3/8"	1-3/8"	21/32"	2-11/16"	1/2"	R3ZZ	\$28.90

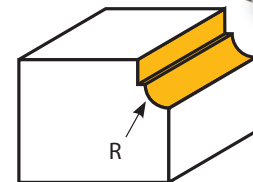

Cove with Fillet Bits with 3/8" Bearing

This bit is great for decorative edges on moldings, tables, mantels, picture frames, furniture, cabinet doors and much more!

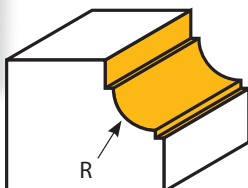

ITEM	Cutting Radius	D Cutting Diameter	I Cutting Length	L Overall Length	S Shank Diameter	Bearing	Sale
742541	3/16"	1"	1/2"	2-3/16"	1/4"	R166ZZ	\$21.90
742861	1/4"	1-1/8"	17/32"	2-1/4"	1/4"	R166ZZ	\$22.90
743181	5/16"	1-1/4"	19/32"	2-1/4"	1/4"	R166ZZ	\$24.90
743491	3/8"	1-3/8"	21/32"	2-3/8"	1/4"	R166ZZ	\$27.90
742542	3/16"	1"	1/2"	2-13/32"	1/2"	R166ZZ	\$22.90
742862	1/4"	1-1/8"	17/32"	2-9/16"	1/2"	R166ZZ	\$23.90
743182	5/16"	1-1/4"	19/32"	2-5/8"	1/2"	R166ZZ	\$25.90
743492	3/8"	1-3/8"	21/32"	2-11/16"	1/2"	R166ZZ	\$28.90

Roman Ogee Bits with Bearing

For decorative edges on furniture, moldings, signs and plaques. Lower the bit to get a decorative bead.

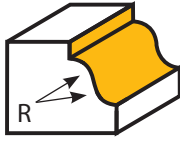

ITEM	R Cutting Radius	D Cutting Diameter	I Cutting Length	L Overall Length	S Shank Diameter	Bearing	Sale
692861	5/32"	1-1/8"	1/2"	2-1/8"	1/4"	R3ZZ	\$19.90
693811	1/4"	1-1/2"	11/16"	2-3/8"	1/4"	R3ZZ	\$28.90
692862	5/32"	1-1/8"	1/2"	2-1/2"	1/2"	R3ZZ	\$20.90
693812	1/4"	1-1/2"	11/16"	2-3/4"	1/2"	R3ZZ	\$30.90

Ogee with Fillet Bits with Bearing

Takes the Roman Ogee a step further, with a horizontal bead in the middle of the profile. Appropriate for classical projects that need more detail.

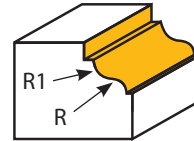

ITEM	R Cutting Radius	R1 Cutting Radius	D Cutting Diameter	I Cutting Length	L Overall Length	S Shank Diameter	Bearing	Sale
753491	5/32"	3/16"	1-3/8"	1/2"	2-1/8"	1/4"	R3ZZ	\$28.90
754131	3/16"	1/4"	1-5/8"	3/4"	2-7/16"	1/4"	R3ZZ	\$36.90
753492	5/32"	3/16"	1-3/8"	1/2"	2-3/8"	1/2"	R3ZZ	\$29.90
754132	3/16"	1/4"	1-5/8"	3/4"	2-13/16"	1/2"	R3ZZ	\$36.90

Classical Ogee Beading Bits with 3/8" Bearing

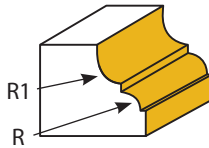

This bit features an inverted Ogee profile with the concave edge next to the upper part of the stock. A vertical bead separates the two curves creating an eye-catching shape.



ITEM	R Cutting Radius	R1 Cutting Radius	D Cutting Diameter	I Cutting Length	L Overall Length	S Shank Diameter	Bearing	Sale
652861	5/32"	5/32"	1-1/8"	1/2"	2-5/32"	1/4"	R166ZZ	\$24.90
653331	1/4"	5/32"	1-5/16"	5/8"	2-5/16"	1/4"	R166ZZ	\$29.90
652862	5/32"	5/32"	1-1/8"	1/2"	2-7/16"	1/2"	R166ZZ	\$25.90
653332	1/4"	5/32"	1-5/16"	5/8"	2-9/16"	1/2"	R166ZZ	\$30.90

Classical Ogee Bits with 1/2" Bearing

This bit features an inverted Ogee profile with the concave edge next to the upper part of the stock. A vertical bead separates the two curves creating an eye-catching shape.

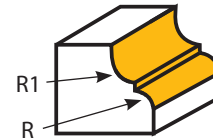

ITEM	R Cutting Radius	R1 Cutting Radius	D Cutting Diameter	I Cutting Length	L Overall Length	S Shank Diameter	Bearing	Sale
642861	5/32"	5/32"	1-1/8"	1/2"	2-5/32"	1/4"	R3ZZ	\$24.90
643331	1/4"	5/32"	1-5/16"	5/8"	2-5/16"	1/4"	R3ZZ	\$29.90
642862	5/32"	5/32"	1-1/8"	1/2"	2-7/16"	1/2"	R3ZZ	\$25.90
643332	1/4"	5/32"	1-5/16"	5/8"	2-9/16"	1/2"	R3ZZ	\$30.90

Ogee Bits with 1/2" Bearing

A perfect accent edge for drawer fronts. The Ogee is the mirror image of the Roman Ogee.



ITEM	R Cutting Radius	D Cutting Diameter	I Cutting Length	L Overall Length	S Shank Diameter	Bearing	Sale
663181	3/16"	1-1/4"	1/2"	2-3/16"	1/4"	R3ZZ	\$25.90
663811	1/4"	1-1/2"	5/8"	2-5/16"	1/4"	R3ZZ	\$29.90
663182	3/16"	1-1/4"	1/2"	2-7/16"	1/2"	R3ZZ	\$26.90
663812	1/4"	1-1/2"	5/8"	2-11/16"	1/2"	R3ZZ	\$30.90
665082	3/8"	2"	7/8"	2-7/8"	1/2"	R3ZZ	\$45.90

Ogee with Beading Bits with 3/8" Bearing

Lower the bit to get an extra bead at the bottom.

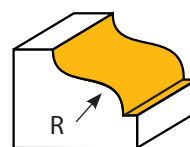

ITEM	R Cutting Radius	D Cutting Diameter	I Cutting Length	L Overall Length	S Shank Diameter	Bearing	Sale
673181	3/16"	1-1/4"	1/2"	2-3/16"	1/4"	R166ZZ	\$25.90
673811	1/4"	1-1/2"	5/8"	2-5/16"	1/4"	R166ZZ	\$29.90
673182	3/16"	1-1/4"	1/2"	2-7/16"	1/2"	R166ZZ	\$26.90
673812	1/4"	1-1/2"	5/8"	2-11/16"	1/2"	R166ZZ	\$30.90
675082	3/8"	2"	7/8"	2-7/8"	1/2"	R166ZZ	\$45.90

Double Fillet Ogee Bits with 3/8" Bearing

MARC'S TIP: If you don't see a profile you need, try layering 2 or more different bits with multiple passes, especially on thicker stock.

All of the above are used for decorative edges on moldings, tables, mantels, picture frames, furniture, cabinet doors, and much more.

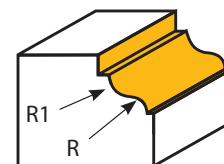

ITEM	R Cutting Radius	R1 Cutting Radius	D Cutting Diameter	I Cutting Length	L Overall Length	S Shank Diameter	Bearing	Sale
763491	5/32"	3/16"	1-3/8"	1/2"	2-1/8"	1/4"	R166ZZ	\$28.90
764131	3/16"	1/4"	1-5/8"	3/4"	2-7/16"	1/4"	R166ZZ	\$36.90
763492	5/32"	3/16"	1-3/8"	1/2"	2-3/8"	1/2"	R166ZZ	\$28.90
764132	3/16"	1/4"	1-5/8"	3/4"	2-13/16"	1/2"	R166ZZ	\$36.90

Router Bit Sets for Doors, Drawers and Decorative Effects

Router bits have an endless variety of uses in the cabinet shop. These sets from Marc Sommerfeld are ideal for making cabinet doors, especially when used with the doormaking templates shown on page 26. The Cabinetmaking Set also includes decorative ogee door & drawer front profiles.



Cabinetmaking Set
See page 13



Glass Panel Set
See page 14 & 15



Raised Panel Set
See page 12



Junior Raised Panel Set
See page 20



Shaker Set
See page 14

Finger Joint Bit



Our one-piece finger joint bit is designed with a bearing, which eliminates the need for fence alignment. You can make perfect edge and end-grain joints while increasing the glue surface area to make joints stronger than the wood itself. Ideal for joining wood and wood composites. Replaces mortise and tenon joints in many cases. Can even be used in miter joints. Quick and accurate set-ups.

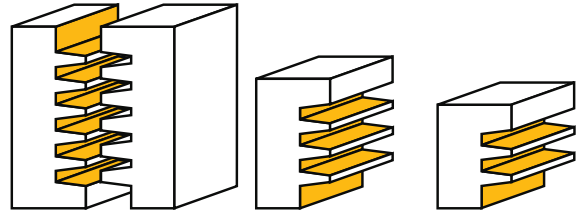

ITEM	D Cutting Diameter	I Cutting Length	L Overall Length	S Shank Diameter	Bearing	Sale
FJ4202A	1-21/32"	1-1/2"	3-15/16"	1/2"	HC293DZZ	\$83.90

Window Sash Bit

Our window sash bit is a 1-bit design, which makes it easier to use on both cuts since a bearing is in use on each cut. Create wooden windows with ease in stock up to 1 3/8" thick and as thin as 1 1/4".

**Mix 'N Match
on ALL
Individual Bits!**

**Buy 2 SAVE 10%
Buy 3 SAVE 15%
Buy 4+ SAVE 20%**

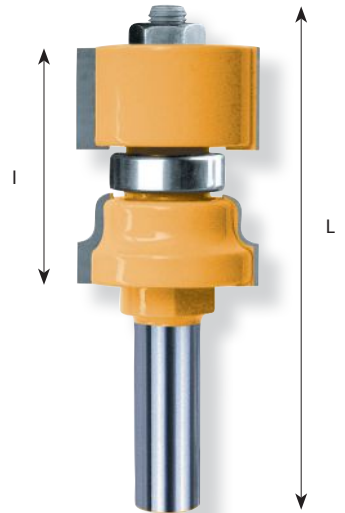
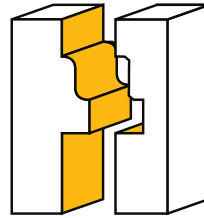

ITEM	D Cutting Diameter	I Cutting Length	L Overall Length	S Shank Diameter	Bearing	Sale
803492W	1-3/8"	1-25/32"	3-13/16"	1/2"	608ZZ	\$66.90

Bird's Mouth Joint Bits

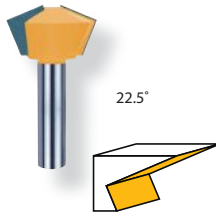
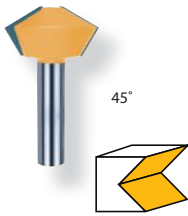
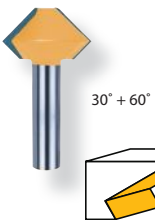

6 or 12-Sided
Projects

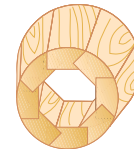

8-Sided Projects



16-Sided Projects

An easy, strong mechanical joint can be produced to create 6, 8, 12, or 16-sided projects. For 6 or 8-sided projects, cut face up. For 12 or 16-sided projects, cut face down.

ITEM	Cutting Angle	D Cutting Diameter	I Cutting Length	L Overall Length	S Shank Diameter	Sale
BM4132A	30° + 60°	1-5/8"	7/8"	2-3/4"	1/2"	\$38.90
BM3812B	45°	1-1/2"	7/8"	2-3/4"	1/2"	\$35.90
BM3812C	22.5°	1-1/2"	7/8"	2-3/4"	1/2"	\$36.90

Architectural Molding Profile Bits

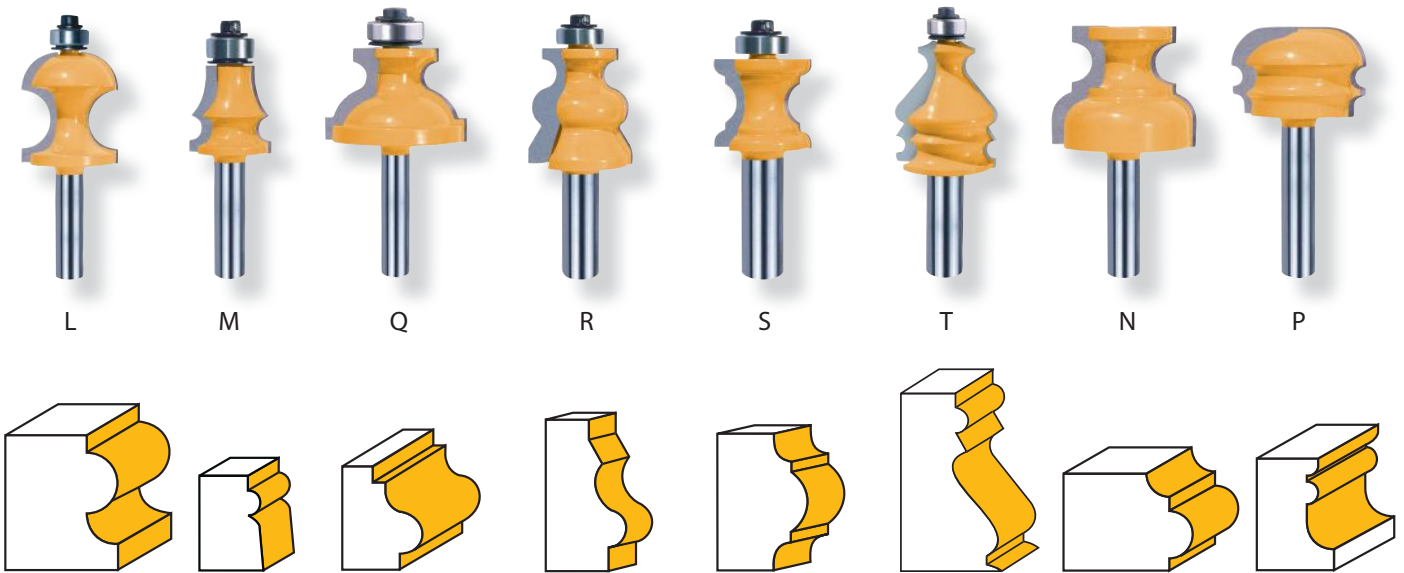

This is one of the largest selections of molding profile bits around. We have a wide choice of different cutting lengths and compatible profiles which can be used in pairs to create your own custom molding that no one else has. Stamp your own personality on your project, while saving time and money. Great for architectural millwork, base and cabinet moldings, window & door casings, windowsills, baseboards, picture frames, and panel moldings.



ITEM	D Cutting Diameter	I Cutting Length	L Overall Length	S Shank Diameter	Bearing	Sale
863181L	1-1/4"	1-3/8"	3-3/8"	1/4"	R3ZZ	\$44.90
862101M	53/64"	7/8"	2-1/2"	1/4"	R3ZZ	\$37.90
864001Q	1-9/16"	1"	2-7/8"	1/4"	R3ZZ	\$45.90
863491N	1-3/8"	1-1/8"	2-3/8"	1/4"		\$44.90
863181P	1-1/4"	25/32"	2-1/16"	1/4"		\$28.90
863492R	1-3/8"	1-1/2"	3-1/2"	1/2"	R3ZZ	\$48.90
862862S	1-1/8"	1"	3"	1/2"	R3ZZ	\$40.90
863492S	1-9/16"	1-5/8"	3"	1/2"	R3ZZ	\$51.90
863492T	1-3/8"	1-5/8"	3-1/2"	1/2"	R3ZZ	\$51.90

Triple Bead Bits

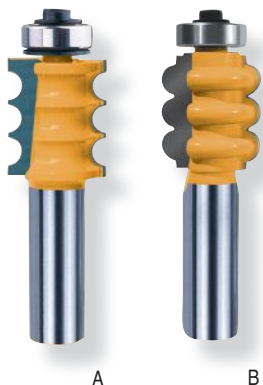

Used for decorative edges on moldings, picture frames, and edge banding. One or more beads can be cut in one pass.

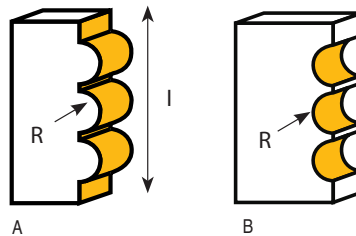

MARC'S TIP:

You can also use this bit for making 1/4" diameter tenon pieces to be inserted as a spline between 2 matching mortises made with a regular 1/4" drill bit.

ITEM	R Cutting Radius	D Cutting Diameter	I Cutting Length	L Overall Length	S Shank Diameter	Bearing	Sale
852222A	1/8"	7/8"	1"	2-29/32"	1/2"	R4ZZ	\$29.90
852222B	1/8"	7/8"	1"	2-7/8"	1/2"	R4ZZ	\$29.90

Molding Profile Bits



B



C



D



E



H



I



K

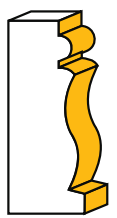
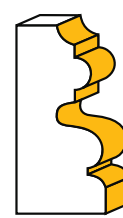
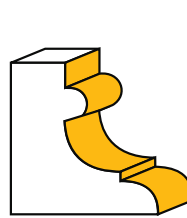
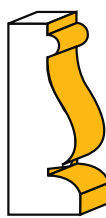
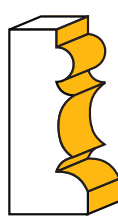
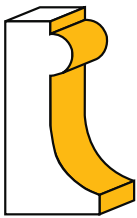

Now you can make your own molding! **SOMMERFELD'S** bits allow you to create a wide variety of designs with many bits.

Produce architectural millwork, moldings, baseboards and chair rails.



ITEM	H Cutting Depth	D Cutting Diameter	I Cutting Length	L Overall Length	S Shank Diameter	Bearing	Sale
862222B	3/16"	7/8"	1-5/8"	3-9/16"	1/2"	R3ZZ	\$40.90
862222C	3/16"	7/8"	1-5/8"	3-9/16"	1/2"	R3ZZ	\$41.90
862542D	1/4"	1"	1-3/8"	3-3/8"	1/2"	R3ZZ	\$42.90
862862E	5/16"	1-1/8"	1-5/8"	3-17/32"	1/2"	R3ZZ	\$43.90
864452H	5/8"	1-3/4"	1-1/8"	3-7/64"	1/2"	R3ZZ	\$47.90
863812I	1/2"	1-1/2"	1-1/2"	3-29/64"	1/2"	R3ZZ	\$57.90
862542K	1/4"	1"	1-5/8"	3-9/16"	1/2"	R3ZZ	\$46.90

Multi-Form Molding Bits

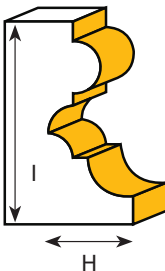

Now you can easily produce dozens of different profiles with the same bit. Simply adjusting the height of the bit or the position of your router table fence and making multiple passes can create small or large moldings. To create small moldings, route your profile onto a large piece of stock and then trim off on the table saw.

ITEM	H Cutting Depth	D Cutting Diameter	I Cutting Length	L Overall Length	S Shank Diameter	Bearing	Sale
863491A	7/16"	1-3/8"	1"	2-3/4"	1/4"	R3ZZ	\$52.90
865712A	7/8"	2-1/4"	1-7/8"	4"	1/2"	R3ZZ	\$69.90

Hand Rail Bits

Now you can produce your own custom stair hand rails in any type of wood.

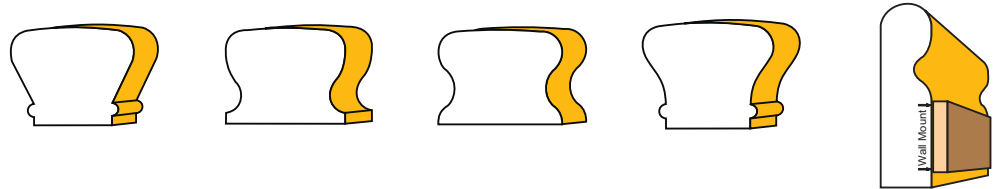

MARC'S TIP:

First, make the two top cuts using an edge forming bit, like one of our Table Edge bits on page 53.

Second, turn the wood over and make the two hand rail cuts. See above profiles for this cut.

ITEM	D Cutting Diameter	I Cutting Length	L Overall Length	S Shank Diameter	B Bearing Diameter	Bearing	Sale
873492A	1-3/8"	1-1/2"	3-3/8"	1/2"	1/2"	R3ZZ	\$45.90
873182B	1-1/4"	1-1/2"	3-3/8"	1/2"	5/8"	R4ZZ	\$43.90
873182C	1-1/4"	1-1/2"	3-3/8"	1/2"	5/8"	R4ZZ	\$43.90
873812D	1-1/2"	3/4"	2-1/4"	1/2"			\$34.90
873182E	1-1/2"	2"	3-15/16"	1/2"	1/2"	R3ZZ	\$53.90

Rabbeting Bits

Cut perfectly-smooth, accurately-dimensioned rabbets on your router table in a fraction of the time it would take you to configure a dado set.

Rabbeting is one of the most common joints in woodworking. These bits will give you fast, accurate results with no tear out on entry cuts and a perfectly milled finish.

Mix 'N Match
on **ALL**
Individual Bits!

Buy 2 SAVE 10%
Buy 3 SAVE 15%
Buy 4+ SAVE 20%

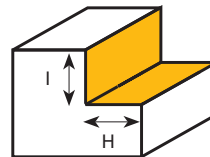

ITEM	H Cutting Depth	D Cutting Diameter	I Cutting Length	L Overall Length	S Shank Diameter	Bearing	Sale
701901	1/8"	3/4"	1/2"	1-15/16"	1/4"	R3ZZ	\$16.90
702541	1/4"	1"	1/2"	2-1/8"	1/4"	R3ZZ	\$18.90
702861	5/16"	1-1/8"	1/2"	2-1/8"	1/4"	R3ZZ	\$20.90
703181	3/8"	1-1/4"	1/2"	2-1/8"	1/4"	R3ZZ	\$20.90
703491	7/16"	1-3/8"	1/2"	2-1/8"	1/4"	R3ZZ	\$25.90
703811	1/2"	1-1/2"	1/2"	2-1/8"	1/4"	R3ZZ	\$27.90
702542	1/4"	1"	1/2"	2-1/2"	1/2"	R3ZZ	\$18.90
702862	5/16"	1-1/8"	1/2"	2-1/2"	1/2"	R3ZZ	\$21.90
703182	3/8"	1-1/4"	1/2"	2-1/2"	1/2"	R3ZZ	\$21.90
703492	7/16"	1-3/8"	1/2"	2-1/2"	1/2"	R3ZZ	\$25.90
703812	1/2"	1-1/2"	1/2"	2-1/2"	1/2"	R3ZZ	\$27.90
704452	5/8"	1-3/4"	1/2"	2-1/2"	1/2"	R3ZZ	\$35.90



Sommerfeld's Easy Set Jig

Eight perfectly matched bit profiles on a base you micro-adjust to your stock thickness – just dial it in, match up the profiles and you're ready to go!

Until the ingenious Easy Set came along, setting complex profile (i.e. lock miter, drawer lock & glue joint) bit heights was both time-consuming and frustrating. But now, this simple device positions your bit perfectly the first time, every time for cutting any thickness of wood from 23/32" to 1-3/16" at the twist of the dial.

Set the dial for the thickness of your stock

Each mark on the rotating dial lifts the height of the jig profile above the router table surface by 1/128" – so two complete rotations of the Easy Set's dial moves you through the full height range.

Select the bit profile you're planning to use

Install one of the eight matching Sommerfeld's router bits in your router's collet and position the Easy Set on your router table's surface with the appropriate profile next to the router bit.

Move your router bit up or down until it meshes perfectly with the profile on the Easy Set jig. Lock your router bit height into position and go to work. It's just that simple.

The eight Sommerfeld's router bits that match the profiles on the **Easy Set Jig include:** Tongue & Groove Cutters • 45° Lock Miter • 22.5° Lock Miter • Glass Panel Cope • Reversible Glue Joint • Raised Panel Cope • Baby Lock Miter

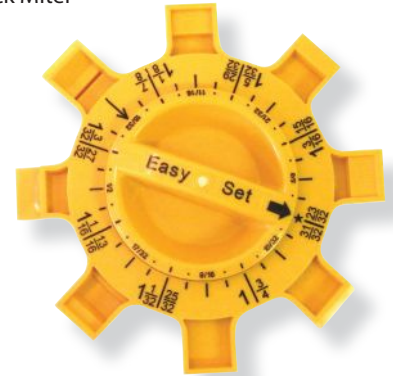

Numbers on movable dial indicate setting for Baby Lock Miter.

ITEM	Description	Sale
EZSET	Easy Set Router Set-Up Jig	\$29.90

Determine exact stock thickness with this digital fractional caliper
SEE PAGE 68



Sommerfeld's 22-1/2° Lock Miter Set



Use this set almost anywhere you need a good solid angle, like this beautiful hardwood kitchen.

Octagonal shapes are very popular for kitchen corner cabinets, entertainment centers, kitchen islands and corner hutches, but the joints used to be difficult to cut and a nightmare to clamp. Now, Sommerfeld's 22.5° Lock Miter Set provides a fast, accurate way to build a strong, tight 45° joint. Better still, the lock miter design makes it easy to clamp!

This matched pair of cutters makes set-up easy. Height adjustment is not critical - simply adjust your fence so the top edge of the work piece intersects the angle of the bit where it meets the fence. After your joints are machined, they can be glued and assembled and simply clamped by using strapping tape.



Bit height set-up is a breeze with our Easy Set Jig
SEE ABOVE

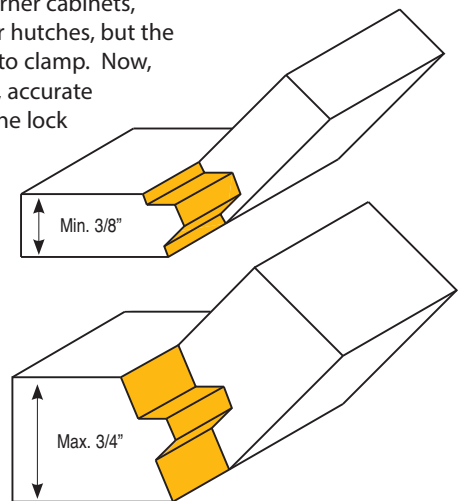

ITEM	Overall Diameter	Cutting Angle	Cutting Length	Max Joint Thickness	Shank Diameter	Sale
02004	1-15/32"	22.5°	7/8"	3/4"	1/2"	\$84.90

45° Lock Miter Bit

These bits join materials at 90° by cutting a 45° miter and a matching tongue & groove at the same time. Makes a beautiful-looking joint with no edge or end grain. Extremely strong joint with lots of glue surface, which aligns and locks together automatically. Used in boxes, hollow-beams, columns, and cabinet corners. When the bit is positioned properly with Sommerfeld's Easy Set, both pieces can be run without moving the bit. One piece is run vertically while the other is run horizontally. Minimum stock size is 3/4" and max is 1-1/8".

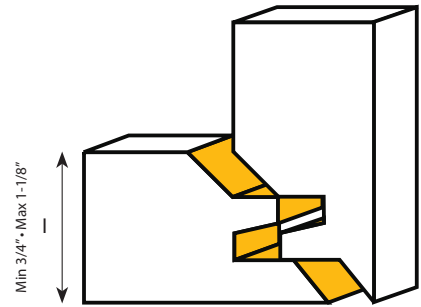

Bit height set-up is a breeze with our Easy Set Jig
SEE PAGE 50

ITEM	D Cutting Diameter	I Cutting Length	Max Joint Thickness	S Shank Diameter	Sale
01006	2-3/4"	1-1/4"	1-1/8"	1/2"	\$71.90

Baby Lock Miter Bit



This bit cuts a strong miter joint also. Use the Baby Lock Miter Bit with stock from 3/8" to 3/4" thick. Build boxes, frames, beams, face-frame corners and many other right-angle joints. Maximum safe speed is 16,000 RPM.

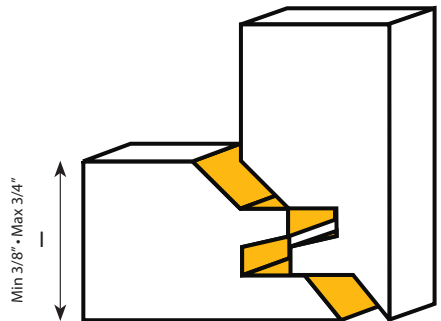

Bit height set-up is a breeze with our Easy Set Jig
SEE PAGE 50

ITEM	D Cutting Diameter	I Cutting Length	Max Joint Thickness	S Shank Diameter	Sale
01007	2"	7/8"	3/4"	1/2"	\$54.90

Reversible Glue Joint Bit

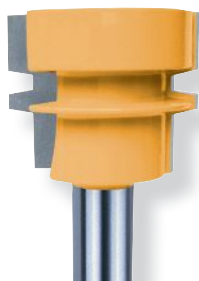

Produces a strong glue edge joint for door panels, tabletops, desktops and cabinets. Position the bit fast and easy with **SOMMERFELD'S** Easy Set (See page 50) and cut both tongue and groove in one pass. Cut first piece face down and second piece face up.

Minimum Thickness 19/32"
Maximum Thickness 1-3/16"

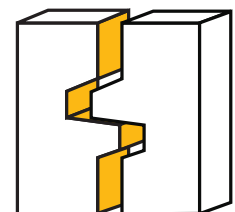

Bit height set-up is a breeze with our Easy Set Jig
SEE PAGE 50

ITEM	D Cutting Diameter	Max Joint Thickness	S Shank Diameter	Sale
01008	1-3/4"	1-3/16"	1/2"	\$52.90

Drawer Lock Joint Bit

This bit allows you to make drawers faster, easier, and safer, but yet strong and durable. Again, use your Sommerfeld's Easy Set to accurately set the height of your bit. Route the drawer front with the inside face down on the router table. Route the two side ends of the drawer with the inside face against the router table fence. The sides should be placed vertical to the bit and fence, and perpendicular to the table.

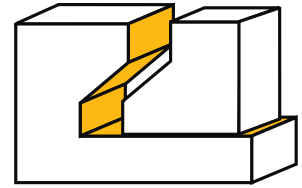

Minimum Thickness 5/8"
Maximum Thickness 3/4"



Bit height set-up is a breeze with our Easy Set Jig
SEE PAGE 50

ITEM	D Cutting Diameter	I Cutting Length	S Shank Diameter	Sale
01009	2"	1/2"	1/2"	\$52.90

135° Edge Molding Bits

These molding bits are used for edge forming moldings.

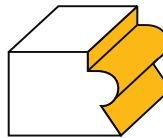

ITEM	R Cutting Radius	D Cutting Diameter	I Cutting Length	L Overall Length	S Shank Diameter	Sale
122901C	5/32"	1-1/8"	5/8"	1-13/16"	1/4"	\$22.90
123101C	1/4"	1-1/4"	3/4"	2"	1/4"	\$26.90
123601C	5/16"	1-3/8"	1"	2-1/8"	1/4"	\$30.90

135° Edge Molding Bits with Bearing

These molding bits are used for edge forming moldings.

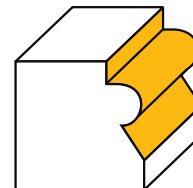

ITEM	R Cutting Radius	D Cutting Diameter	I Cutting Length	L Overall Length	S Shank Diameter	Bearing Number	Sale
122901D	5/32"	1-1/8"	5/8"	2-1/4"	1/4"	R3ZZ	\$25.90
123101D	1/4"	1-1/4"	3/4"	2-3/8"	1/4"	R3ZZ	\$29.90
123601D	5/16"	1-3/8"	1"	2-5/8"	1/4"	R3ZZ	\$32.90

Drawer Edge Bit with Bearing

This bit makes a miniature cove raised panel look on drawer fronts. Mill the faces of the drawer front with minimal work.

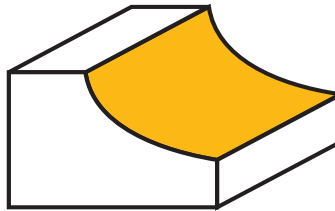

ITEM	R Cutting Radius	D Cutting Diameter	I Cutting Length	L Overall Length	S Shank Diameter	Bearing	Sale
715082	3/4"	2"	1/2"	2-1/2"	1/2"	R3ZZ	\$42.90

Table Edge Bits

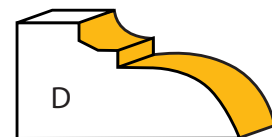
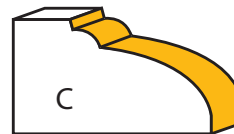

Mix 'N Match
on **ALL**
Individual Bits!

Buy 2 SAVE 10%
Buy 3 SAVE 15%
Buy 4+ SAVE 20%

These bits are used to form a deep, decorative detail found on tables, window sills, and chair rails. Best results are achieved by taking multiple passes on the router table.



ITEM	D Cutting Diameter	I Cutting Length	L Overall Length	S Shank Diameter	Bearing Number	Sale
716352B	2-1/2"	3/4"	2-53/64"	1/2"	R3ZZ	\$57.90
716352C	2-1/2"	3/4"	2-43/64"	1/2"	R3ZZ	\$55.90
713812D	1-1/2"	21/32"	2-1/2"	1/2"	R3ZZ	\$30.90

Reversible Door Edge Bit

Mix 'N Match
on ALL
Individual Bits!

Buy 2 SAVE 10%
Buy 3 SAVE 15%
Buy 4+ SAVE 20%



Now you can create a door handle with no hardware. This bit machines in one pass a finger pull profile that visually thins the door edge also. Can also be used for table edges.

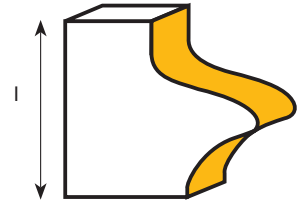

ITEM	D Cutting Diameter	I Cutting Length	L Overall Length	S Shank Diameter	Sale
714132A	1-5/8"	1"	2-1/2"	1/2"	\$44.90

Door Lip Bits

Finish your door edges professionally in one pass. Used for rabbeted back doors.

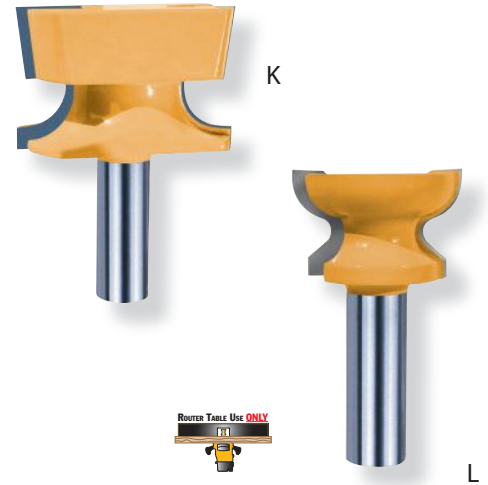
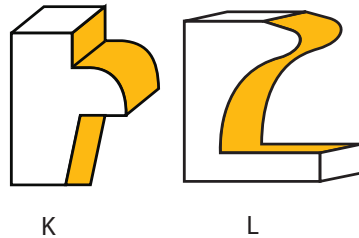

ITEM	D Cutting Diameter	I Cutting Length	L Overall Length	S Shank Diameter	Sale
715082K	2"	1-3/16"	2-3/4"	1/2"	\$46.90
713491L	1-3/8"	7/8"	2-1/8"	1/4"	\$31.90
713492L	1-3/8"	7/8"	2-3/8"	1/2"	\$31.90

Drawer Pull Bits

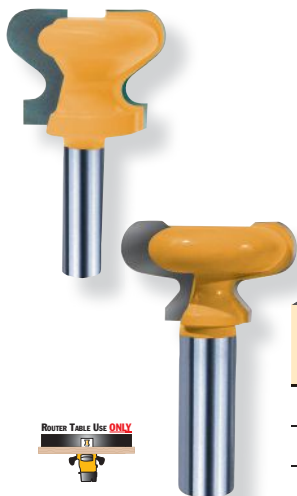

Used to produce a finger pull on drawer face or edge. Why use a metal knob or handle? Make a wooden handle that blends into the door.

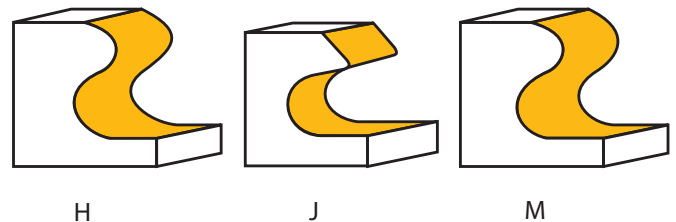

ITEM	R1 Cutting Radius	R2 Cutting Radius	D Cutting Diameter	I Cutting Length	L Overall Length	S Shank Diameter	Sale
711901H	3/16"	3/32"	3/4"	11/16"	1-15/16"	1/4"	\$23.90
713812J	15/64"	1/16"	1-1/2"	7/8"	2-3/8"	1/2"	\$34.90
713001M	3/16"	3/32"	1-11/64"	7/8"	2-1/16"	1/4"	\$31.90

Variable Slot Cutter Set

This slot cutter set allows you to cut slots, grooves, and rabbets from 1/8" to 23/32" wide. Ideal for biscuit joints! Use individually or in a combination to produce different groove widths. Set includes 1/8", 5/32", 3/16" and 1/4" slot cutters.

Mix 'N Match
on **ALL**
Individual Bits!

Buy 2 SAVE 10%
Buy 3 SAVE 15%
Buy 4+ SAVE 20%

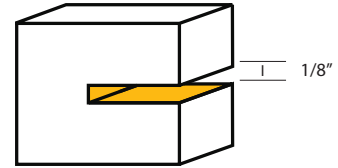
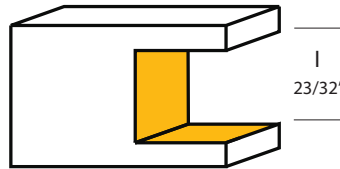
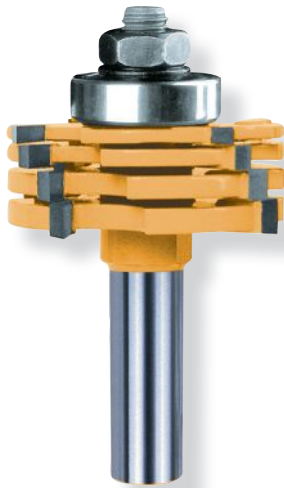

ITEM	D Cutting Diameter	I Cutting Length	L Overall Length	S Shank Diameter	Bearing	Sale
SL5082A	2"	1/8", 5/32", 3/16", 1/4"	3-7/64"	1/2"	HC254DZZ	\$78.90

3-Wing Slot Cutters

Our slot cutters have many uses. These slot cutters are 1-7/8" in diameter. Cutters are interchangeable and can be combined to give you a wide variety of cuts.

Make sure cutters are put on the arbor in the correct cutting direction and always use spacers between cutters and bearings. Cut box joints, T-molding, lap joints, and biscuit joints. Standard biscuit cutter is 5/32"

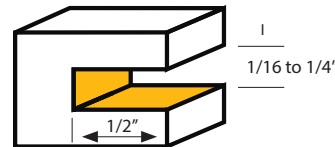

1/4" Shank Bits

ITEM	I Kerf	Shank Diameter	Bearing	Sale
704761A-3	1/16"	1/4"	608ZZ	\$28.90
704761B-3	5/64"	1/4"	608ZZ	\$23.90
704761C-3	3/32"	1/4"	608ZZ	\$23.90
704761D-3	1/8"	1/4"	608ZZ	\$23.90
704761E-3	5/32"	1/4"	608ZZ	\$25.90
704761F-3	3/16"	1/4"	608ZZ	\$25.90
704761G-3	7/32"	1/4"	608ZZ	\$27.90
704761H-3	1/4"	1/4"	608ZZ	\$27.90

1/2" Shank Bits

ITEM	I Kerf	Shank Diameter	Bearing	Sale
704762A-3	1/16"	1/2"	608ZZ	\$31.90
704762B-3	5/64"	1/2"	608ZZ	\$28.90
704762C-3	3/32"	1/2"	608ZZ	\$23.90
704762D-3	1/8"	1/2"	608ZZ	\$23.90
704762E-3	5/32"	1/2"	608ZZ	\$25.90
704762F-3	3/16"	1/2"	608ZZ	\$25.90
704762G-3	7/32"	1/2"	608ZZ	\$27.90
704762H-3	1/4"	1/2"	608ZZ	\$27.90
704762K-3	9/32"	1/2"	608ZZ	\$31.90

Slotting Cutters



Sommerfeld's 3-wing slot cutters will give you clean entry cuts without kickback while producing square slots with a clean, flat bottom.

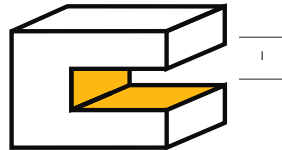

3-Wing Slotting Cutter Blade

ITEM	D Cutting Diameter	I Kerf	Sale
SCB3A	1-7/8"	1/16"	\$19.90
SCB3B	1-7/8"	5/64"	\$19.90
SCB3C	1-7/8"	3/32"	\$19.90
SCB3D	1-7/8"	1/8"	\$19.90
SCB3E	1-7/8"	5/32"	\$21.90
SCB3F	1-7/8"	3/16"	\$21.90
SCB3G	1-7/8"	7/32"	\$23.90
SCB3H	1-7/8"	1/4"	\$23.90
SCB3K	1-7/8"	9/32"	\$24.90

12-Pc Three Wing Slot-Cutting Set

Cut slots from 1/8" to 1-1/8" wide with this versatile set

This special, carbide-tipped, stacking Slot Cutter Set lets you cut slots from 1/8" wide to 1-1/8" wide in a single pass. Just stack the 1-7/8" diameter cutters onto one of the two 1/2" diameter arbors to cut a slot as wide as you want. The set includes a total of six cutters: (one) 1/8" wide – (one) 5/32" wide – (one) 3/16" wide – and (three) 1/4" wide.

Also included in the set are two 1/2" diameter arbors with nuts and washers...and four sealed bearings for controlling the depth of each cut:

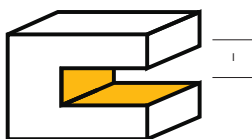

Bearing Diameter	7/8"	1"	1-1/8"	1-3/8"
Depth-of-Cut	1/2"	7/16"	3/8"	1/4"

ITEM	Description	Sale
01014	12-Pc 3-Wing Slotting Cutter Set	\$89.90

Ultimate Rabbet Set

In addition to our Ultimate Rabbet Set making a full 3/4" deep rabbet, it will make 16 other useful cuts

Box has flush-mounted magnetic catch.



This set is a fast and accurate way to produce inset door and drawer faces, cut strong rabbeted joints, inset the backs of cabinets and much, much more. The set is packaged in a custom-designed hardwood case.

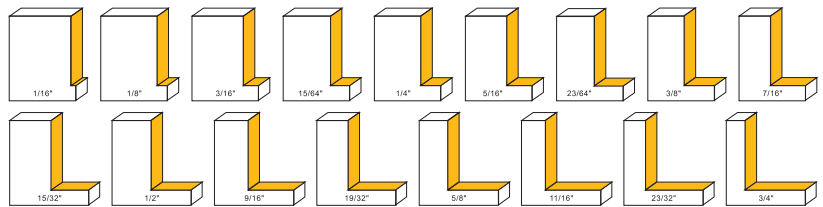

Sommerfeld's Quick Reference Guide for Rabbet and Bearing Sizes

Bearing: 1-7/8" Rabbet: 1/16"	Bearing: 1-3/4" Rabbet: 1/8"	Bearing: 1-5/8" Rabbet: 3/16"	Bearing: 1-17/32" Rabbet: 15/64"
Bearing: 1-1/2" Rabbet: 1/4"	Bearing: 1-3/8" Rabbet: 5/16"	Bearing: 1-1/4" Rabbet: 3/8"	Bearing: 1-9/32" Rabbet: 23/64"
Bearing: 1-1/8" Rabbet: 7/16"	Bearing: 1-1/16" Rabbet: 15/32"	Bearing: 1" Rabbet: 1/2"	Bearing: 7/8" Rabbet: 9/16"
Bearing: 13/16" Rabbet: 19/32"	Bearing: 95/128" Rabbet: 5/8"	Bearing: 5/8" Rabbet: 11/16"	Bearing: 9/16" Rabbet: 23/32"
Bearing: 1/2" Rabbet: 3/4"			

ITEM	Description	Shank Diameter	Sale
17001	Ultimate Rabbeting Set	1/2"	\$129.90

7-Pc Adjustable Depth Rabbeting Set

Now you can get seven different rabbet cuts from only one bit. Each set includes a bit and seven bearings.

This set includes rabbeting bit and 1/2", 5/8", 3/4", 7/8", 1", 1-1/8" and 1-1/4" bearings."

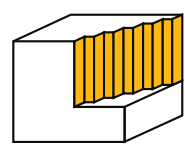

Bearing Diameter	1/2"	5/8"	3/4"	7/8"	1"	1-1/8"	1-1/4"
Depth-of-Cut	1/2"	7/16"	3/8"	5/16"	1/4"	3/16"	1/8"
Bearing	R3ZZ	HC159CZZ	HC190CZZ	HC222CZZ	HC254CZZ	HC286CZZ	HC318CZZ

ITEM	Description	Shank Diameter	Sale
01013	7-Pc Adjustable Depth Rabbeting Set	1/2"	\$59.90



V-Tongue & Groove Set

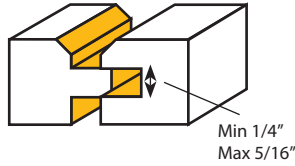

This unique set from Sommerfeld's produces beautiful tongue and groove paneling or flooring with an attractive 45° V-pattern. The difference between this set and other sets is that both our bits have bearings to help guide the workpiece accurately. Our bits are carefully matched, so it's easy to change bits to make the male and female cuts. For fast production on large stocks, set up two router tables with one dedicated to each cutting operation.

ITEM	Overall Diameter	Min Joint Thickness	Max Joint Thickness	Bearing	S Shank Diameter	Sale
02005	1-3/4"	3/4"	7/8"	608ZZ - Top SRI1212ZZ - Middle	1/2"	\$99.90

Letter Bits

Designed for routing signs, these bits have a 60° cutting angle with a 1/8" radius and a 1/4" wide flat bottom. Beveled edges reduce chipping and splintering.

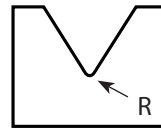

ITEM	R Cutting Radius	D Cutting Diameter	I Cutting Length	L Overall Length	S Shank Diameter	Sale
162541G	1/8"	1"	3/4"	2-1/2"	1/4"	\$22.90
162542G	1/8"	1"	3/4"	2-1/2"	1/2"	\$22.90



Veining Bit

This bit is used extensively in sign making. Make clean cut veins for your signage or decorative projects.

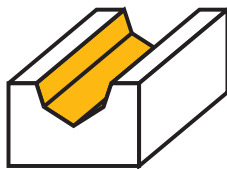

ITEM	D Cutting Diameter	I Cutting Length	L Overall Length	S Shank Diameter	Sale
V080631	1/4"	3/8"	1-3/4"	1/4"	\$18.90

Face Frame V-Groove Trimmers

Cabinetmakers love this bit. It removes the overhang from the face frame while making it flush to the side, plus it cuts a decorative V-Groove, which hides the jointing pieces.

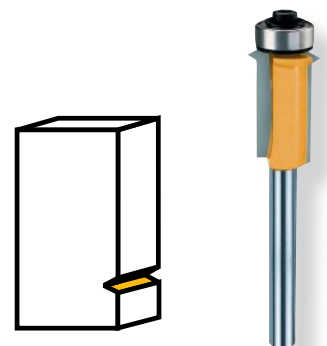

ITEM	D Cutting Diameter	I Cutting Length	L Overall Length	S Shank Diameter	Bearing	Sale
541601A	5/8"	1"	3-1/4"	1/4"	R3ZZ	\$19.90
541602A	5/8"	1"	3-1/4"	1/2"	R3ZZ	\$19.90

Wavy Edge Bits with 1/2" Bearing

Mix 'N Match
on **ALL**
Individual Bits!

Buy 2 **SAVE 10%**
Buy 3 **SAVE 15%**
Buy 4+ **SAVE 20%**



Looking for the right touch? These bits provide a different accent edge to drawer fronts, door and table edges, desks, windowsills, chair and handrails, moldings, and plaques.

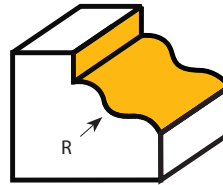

ITEM	R Cutting Radius	D Cutting Diameter	I Cutting Length	L Overall Length	S Shank Diameter	Bearing	Sale
613181B	5/32"	1-1/4"	11/16"	2-1/4"	1/4"	R3ZZ	\$27.90
613182B	5/32"	1-1/4"	11/16"	2-1/2"	1/2"	R3ZZ	\$27.90

Double Roundover Bits with 1/2" Bearing



Looking for the right touch? These bits provide a different accent edge to drawer fronts, door and table edges, desks, windowsills, chair and handrails, moldings, and plaques.

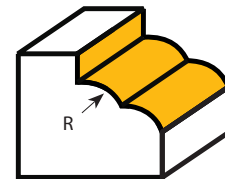

ITEM	R Cutting Radius	D Cutting Diameter	I Cutting Length	L Overall Length	S Shank Diameter	Bearing	Sale
612861C	5/32"	1-1/8"	1/2"	2"	1/4"	R3ZZ	\$26.90
612862C	5/32"	1-1/8"	1/2"	2-1/4"	1/2"	R3ZZ	\$26.90

Vertical Panel Raisers

The Ogee panel cutters require less router power to operate than our traditional horizontal models. They cannot be used with templates to make arched raised panel doors. A tall fence is also needed to help support the vertical run.

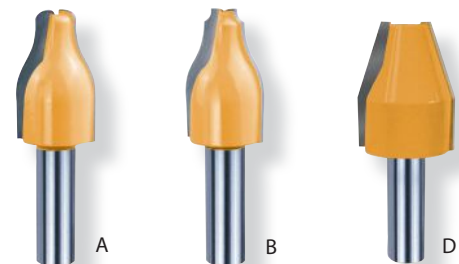

ITEM	D Cutting Diameter	I Cutting Length	L Overall Length	S Shank Diameter	Sale
772542A	1"	1-5/8"	3-3/16"	1/2"	\$49.90
772542B	1"	1-5/8"	3-3/16"	1/2"	\$49.90
773182D	1-1/4"	1-5/8"	3-1/8"	1/2"	\$49.90

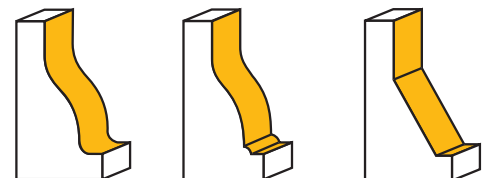



Sommerfeld's Patented Radiused-Corner-Geometry Rail & Stile Bits

Patent Number US 8,491,980 B1



Roundover Rail & Stile Set
ITEM # 02011



Ogee Rail & Stile Set
ITEM # 02012

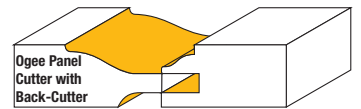
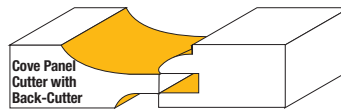
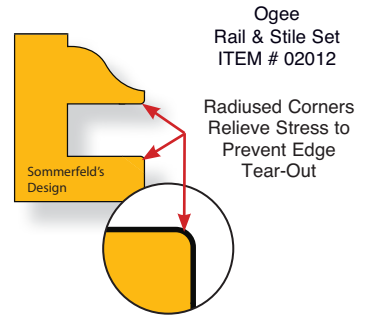
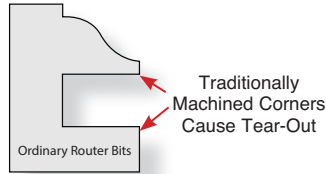

Traditional Rail & Stile Sets - Bearing

SOMMERFELD'S 2-piece Rail & Stile bits are ideal for creating perfectly-fitted rail and stile joinery with 1/2" engagement.

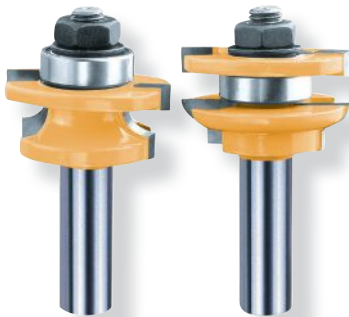

814132R

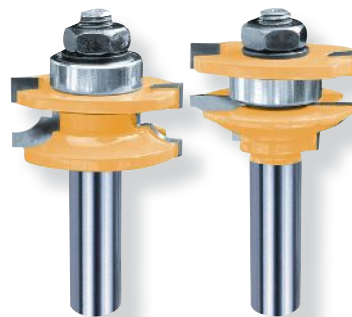
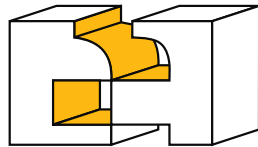

814132B

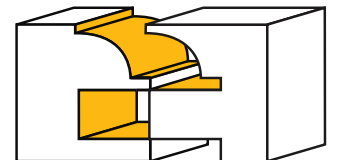

ITEM	Profile	R Cutting Radius	D Cutting Diameter	I Cutting Length	L Overall Length	S Shank Diameter	Bearing	Sale
02011	Roundover	15/32"	1-5/8"	29/32"	3"	1/2"	608ZZ	\$99.90
02012	Ogee	15/32"	1-3/4"	7/8"	3"	1/2"	608ZZ	\$99.90
814132B		15/32"	1-5/8"	29/32"	2-29/32"	1/2"	608ZZ	\$79.90
814132R		15/32"	1-5/8"	29/32"	2-29/32"	1/2"	608ZZ	\$79.90

Cove Raised Panel Bit with Back Cutter

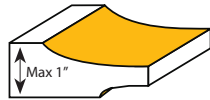

This 3 1/2" diameter bit has a back cutter which allows milling of both the front and back of the panel at the same time. This gives you exactly the thickness you need to insert into your stile. Also, with the back cutter, all 5 pieces of your raised panel door can be cut out of the same thickness of stock and both the front and back of the door will be flush on both sides. The raised panel cutter comes with 2 bearings with the large one installed. If you are making arched or curved raised panels the large bearing allows you to make half the cut since there is no fence involved. After the first cut you change bearings and install the small bearing to finish the cut. If you are doing straight raised panels, you can go immediately to the small bearing and take 2 passes by simply moving the fence. You will love this bit.

ITEM	D Cutting Diameter	L Overall Length	S Shank Diameter	Bearing	Sale
01001	3-1/2"	3-5/16"	1/2"	688ZZ / HC318DZZ	\$89.90

Ogee Raised Panel Bit with Back Cutter

This 3-1/2" diameter bit has a back cutter which allows milling of both the front and back of the panel at the same time. This gives you exactly the thickness you need to insert into your stile. Also, with the back cutter, all 5 pieces of your raised panel door can be cut out of the same thickness of stock and both the front and back of the door will be flush on both sides. An additional small bearing (688ZZ) promotes safety by allowing you to take 2 separate passes. You will love this bit!

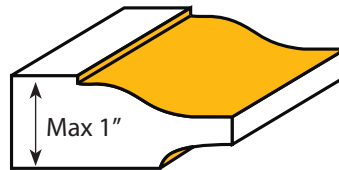

ITEM	D Cutting Diameter	L Overall Length	S Shank Diameter	Bearing	Sale
01015	3-1/2"	3-5/16"	1/2"	688ZZ / HC318DZZ	\$89.90

Shaker Panel Bit with Back Cutter

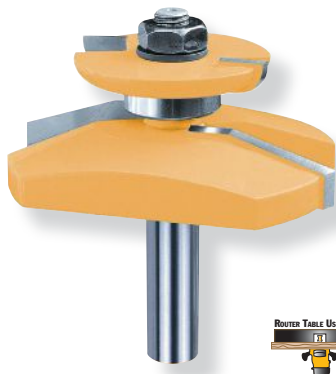

This 3" diameter bit is designed to build your Mission-style furniture or cabinets. This panel cutter is also preset to fit in the 7/32" groove in the stiles and rails. It can also be shimmed to increase the size of the panel to 1/4" to use with standard stile and rail cutters.

Mix 'N Match
on **ALL**
Individual Bits!

Buy 2 SAVE 10%
Buy 3 SAVE 15%
Buy 4+ SAVE 20%

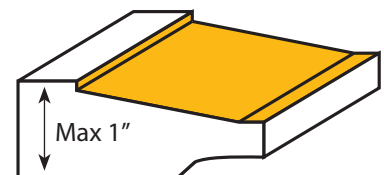

ITEM	D Cutting Diameter	L Overall Length	S Shank Diameter	I Cutting Length	Bearing	Sale
01005	3-1/2"	3-5/16"	1/2"	1"	688ZZ	\$89.90

Cove Raised Panel Bits



These cutters do not have a back cutter. They come in 3 different profiles: Cove, Ogee and Chamfer.

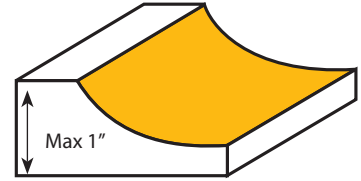

ITEM	R Cutting Radius	D Cutting Diameter	I Cutting Length	L Overall Length	S Shank Diameter	Bearing	Sale
785081	3/4"	2"	13/32"	2-3/16"	1/4"	R3ZZ	\$41.90
785082	3/4"	2"	13/32"	2-1/2"	1/2"	R3ZZ	\$41.90
786352	1"	2-1/2"	1/2"	2-5/8"	1/2"	R3ZZ	\$53.90
788892	1-1/2"	3-1/2"	5/8"	3"	1/2"	R3ZZ	\$79.90

Raised Panel Ogee Bits

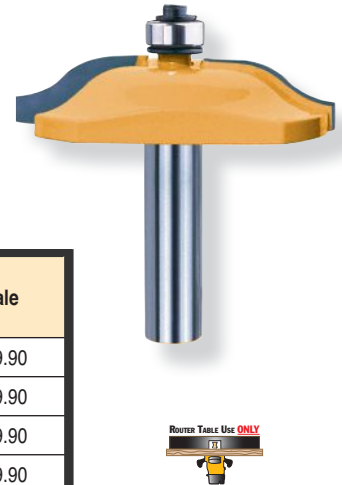
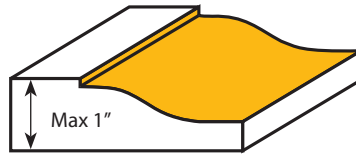

ITEM	R Cutting Radius	D Cutting Diameter	I Cutting Length	L Overall Length	S Shank Diameter	Bearing	Sale
775081	3/4"	2"	1/2"	2-3/16"	1/4"	R3ZZ	\$39.90
775082	3/4"	2"	1/2"	2-1/2"	1/2"	R3ZZ	\$39.90
776352	1"	2-1/2"	5/8"	2-5/8"	1/2"	R3ZZ	\$49.90
776992	1-1/4"	2-3/4"	5/8"	2-7/8"	1/2"	R3ZZ	\$69.90
778892	1-1/2"	3-1/2"	5/8"	3-1/8"	1/2"	R3ZZ	\$79.90

Raised Panel Chamfer Bits

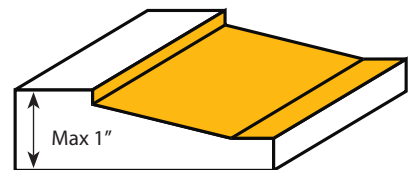

ITEM	Cutting Angle	D Cutting Diameter	I Cutting Length	L Overall Length	S Shank Diameter	Bearing	Sale
794131	25°	1-5/8"	1/2"	2-3/16"	1/4"	R3ZZ	\$35.90
796352	18°	2-1/2"	5/8"	2-3/4"	1/2"	R3ZZ	\$54.90
798262	18°	3-1/4"	5/8"	3-1/8"	1/2"	R3ZZ	\$96.90
798892	18°	3-1/2"	5/8"	3-1/8"	1/2"	R3ZZ	\$99.90

Sommerfeld's Dovetail Jig

The Sommerfeld's Dovetail Jig is a remarkable, easy-to-use system that makes quick work of dovetail joints on your bench or router table.

Quality Construction ensures unwavering precision and long-term durability

The Sommerfeld's Dovetail Jig is designed with single-plate technology. It is constructed with high quality aluminum, then anodized for lasting dependability.

The Sommerfeld's Dovetail Plate can be interchanged with any previous Dovetail Jigs we have sold. The maximum width of the joint is 12" which is the depth of the drawer.

*Not recommended for use with plywood

Pre-assembled Dovetail Jig Includes: Sommerfeld's Dovetail Plate, (2) edge stops, and toaster bar clamps. Also included is the 7/16" dovetail bit, 5/8" pattern bit, 5/32" allen wrench, manual, and DVD8.

HALF-PRICE



HOW-TO DVD
With Purchase Of The
Dovetail Jig
A \$9.90 VALUE

Yours for only \$4.90
DVD: DVD8



Sommerfeld's Dovetail Jig Item # DTJ

SALE: \$239.90

ITEM	Description	Sale
01012	Replacement 5/8" Pattern Bit w/ 1/4" shank	\$19.90
01011	Replacement 7/16" Dovetail Bit w/ 1/4" shank	\$19.90
DTJP	Sommerfeld's Dovetail Plate	\$119.90
DVD8	Dovetails Made Easy DVD	\$9.90
AW015M	Hex Wrench	\$.50
LR1264054-2	Stop Collar	\$1.50
DTJ	Sommerfeld's Dovetail Jig	\$239.90

Dovetail Jig Accessories

Combination Joints

ITEM # 01011 / 01012
Dovetail & Pattern Bits
SALE: \$19.90 ea.

ITEM # DTJ1 / DTJ2
Dovetail & Box Tuning Forks
SALE: \$10.90 ea.

Variable Spaced Cutting Forks

ITEM # DTJ1
Sommerfeld's Dovetail Forks
SALE: \$10.90

ITEM # DTJ2
Box Joint Tuning Fork
SALE: \$10.90

Half Blind Joints

ITEM # 01011A / 01011B
Dovetail & Pattern Bit
SALE: \$19.90 ea.

ITEM # DTJHB
Organic Half-Blind Dovetail Plate with 01011A / 101011B
SALE: \$99.90

Box Joints

ITEM # DTJ2
Box Joint Tuning Fork
SALE: \$10.90 ea.

ITEM # 01012
Pattern Bit
SALE: \$19.90

Dovetail Bits for Stock 3/4" - 1" Thick

ITEM # 01011C
1" Dovetail Bit
SALE: \$19.90

ITEM # 01012C
1" Pattern Bit
SALE: \$19.90

Dovetail Bits for Stock 1/2" - 5/8" Thick

ITEM # 01011 / 01012
Dovetail Bit & Pattern Bit
SALE: \$19.90 ea.

ITEM # DTJP
Sommerfeld Dovetail Plate
SALE: \$119.90

Long-Lasting Coated Blades

SOMMERFELD'S blades are a perfect match for our line of bits!

Each Sommerfeld's saw blade is built on a precision-cut body of the finest Japanese plate steel. "Fish Hooks" are precision set to reduce vibration and noise. The carbide teeth that are "autobrazed" are made from the finest micrograin (Sandvik Carbide, a Swedish company). The teeth are then precision ground to our specifications on German equipment. A non-stick coating is then applied to help your blade avoid corrosion, clean up quickly, and give you many years of service. Whether it's on a contractor's saw or a cabinet saw, you'll love the performance of a Sommerfeld's saw blade.



Computerized Blade Tensioning
Every blade is carefully tensioned for stability, then the arbor and tooth seats are ground on the finest CNC equipment.

Laser Cut Plate
Precision laser cutting eliminates the danger of distortion, which often occurs when blades are stamped.

True Micrograin Carbide
Every tooth is ground from a carefully-selected grade of micrograin carbide, and is held in place by a high-strength tri-metal braze.

Anti-Kickback Design for Safety
Sommerfeld engineers each blade for the safest possible operation. Anti-kickback design helps eliminate the danger of kickback.



10" Compound Miter Saw Blade

You can expect a smooth cut with our Compound Miter Blades. The -5° hook eases the blade through the wood while the high-tooth count gives you that smooth result.

ITEM # 31001
10" Compound Miter Blade

SALE: \$79.90

	EXCELLENT	GOOD	FAIR
Plywood			
Crosscut Wood			
Melamine			
Rip Wood			

Blade Description	ITEM	Diameter Inches	Teeth Z	Bore	Grind	Kerf Inches	Plate Inches	Hook Angle	Sale
Compound Miter	31001	10"	80	5/8"	4ATB+1TGC	0.118	0.0975	-5°	\$79.90



12" Compound Miter Saw Blade

You can expect a smooth cut with our Compound Miter Blades. The -5° hook eases the blade through the wood while the high tooth count gives you that smooth result. Our 12" Compound Miter has 10 more teeth than most blades - 100 teeth in all.

ITEM # 31202
12" Compound Miter Blade

SALE: \$89.90

	EXCELLENT	GOOD	FAIR
Plywood			
Crosscut Wood			
Melamine			
Rip Wood			

Blade Description	ITEM	Diameter Inches	Teeth Z	Bore	Grind	Kerf Inches	Plate Inches	Hook Angle	Sale
Compound Miter	31202	12"	100	1"	4ATB+1TGC	0.118	1.100	-5°	\$89.90



Cabinetmaker Blade

Marc's favorite table saw blade - a blade that does it all. Crosscut or rip any type of wood. No need to change the blade once it's on your saw. The 18° hook angle is aggressive on rip cuts while the alternate bevel makes the cuts smooth. You will love the performance of this saw blade.

ITEM # 31003
Cabinetmaker Blade

SALE: \$59.⁹⁰

	EXCELLENT	GOOD	FAIR
Plywood			
Crosscut Wood			
Rip Wood			
Melamine			

Blade Description	ITEM	Diameter Inches	Teeth Z	Bore	Grind	Kerf Inches	Plate Inches	Hook Angle	Sale
Cabinetmaker	31003	10"	40	5/8"	40ATB	0.130	0.0985	18°	\$59.90

Cabinetmaker Thin Kerf Blade

The Cabinetmaker Thin Kerf Blade is another good blade! Crosscut or rip any type of wood. No need to change the blade once it's on your saw. The 18° hook angle is aggressive on rip cuts while the alternate bevel makes the cuts smooth. The thin kerf is made for under-powered saws but walks right through your stock on regular cabinet saws while reducing waste.

ITEM # 31004
Cabinetmaker Thin Kerf Blade

SALE: \$59.⁹⁰



	EXCELLENT	GOOD	FAIR
Plywood			
Crosscut Wood			
Rip Wood			
Melamine			

Blade Description	ITEM	Diameter Inches	Teeth Z	Bore	Grind	Kerf Inches	Plate Inches	Hook Angle	Sale
Cabinetmaker	31004	10"	40	5/8"	40ATB	0.106	0.0985	18°	\$59.90



Melamine Blade

This is our top finish blade. Great for producing razor-sharp, chip-free cuts on 2-sided Melamine, double-sided laminate, or even veneered plywood. Also, it performs great in crosscutting in hardwoods and softwoods.

ITEM # 31005
Cabinetmaker Thin Kerf Blade

SALE: \$79.⁹⁰

	EXCELLENT	GOOD	FAIR
Plywood			
Crosscut Wood			
Melamine			
Rip Wood			

Blade Description	ITEM	Diameter Inches	Teeth Z	Bore	Grind	Kerf Inches	Plate Inches	Hook Angle	Sale
Melamine	31005	10"	80	5/8"	80ATB	0.126	0.071	5°	\$79.50



Sommerfeld's Easy Bore Hinge Boring Jig

Align and bore three perfectly-positioned hinge mounting holes in seconds with this rugged, time-saving wonder



Our hand-clamped boring jig drills a 35mm hole and two aligning 8mm holes at the same setting, which allows you to accurately install your hinges with ease and speed!

No screwdriver is needed to install, just a hammer to lightly tap the hinges in place. Hinges have special plastic inserts around screws which stay imbedded in wood; hinge can then be unscrewed if needed while finishing.

The jig has adjustable stops which allow for different overlays. We use setting number 2 for 1/2" overlay, number 3 for 3/8" overlay. The cast aluminum alloy frame also incorporates a depth-adjustable carbide-tipped 35mm bit with spurs for clean holes in solid wood, veneers or melamine. The Easy Bore is a strong, versatile unit for shops of all sizes!



Bottom of Easy Bore shows depth-adjustable carbide-tipped cutters



Adjustable stops allow for different overlays



13mm Socket included with Easy Bore

ITEM	Description	Sale
SM923512	35 mm Replacement Bit	\$25.90
SM9700887	8 mm Replacement Bit	\$29.90
SHB	Easy Bore Hinge Boring Jig	\$179.90

Blum Compact Face Frame Hinges

Give your face frame cabinets the quality and performance of concealed European hinges. These top-quality nickel-plated hinges are easy to install and even easier to adjust.

Blum's cam depth adjustment and micro side adjustment screw let you align doors in seconds. And when used with Sommerfeld's Easy Bore Jig, the hinge can simply be driven into the 8mm holes. For a complete demonstration of the Easy Bore and more hinge installation information, see our **Cabinetmaking Made Easy** DVD.

* Face Frame Hinge with Insert

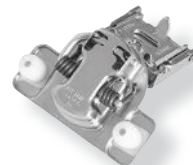

Soft Close Face Frame Hinge with Insert



The hinges with plastic inserts are recommended to be used with the Easy Boring Jig.

ITEM	Overlay	Description	Sale	20 or More
38N355C.06	3/8"	Face Frame Hinge	\$2.45 / EA	\$2.25 / EA
38N355C.08	1/2"	Face Frame Hinge	\$2.45 / EA	\$2.25 / EA
38N358B.06	3/8"	Soft Close Face Frame Hinge w/Inserts	\$3.90 / EA	\$3.70 / EA
38N358B.08	1/2"	Soft Close Face Frame Hinge w/Inserts	\$3.90 / EA	\$3.70 / EA
38N358C.08	1/2"	*Face Frame Hinge w/ Inserts	\$2.45 / EA	\$2.25 / EA

Drawer Slide Installation Jigs

Makes quick work of a tedious task!

Tandem Drawer Slide Mounting Tool

The Tandem Under Mounting Drawer Slide Jig is designed to simplify

the installation of Tandem Drawer Slides. It has 4 rare earth magnets with steel cups which give each magnet around 27 lbs. of holding power allowing you the option to clamp the jig to the face of the cabinet or use it free hand.



ITEM # TDST Tandem Drawer Slide Mounting Tool **SALE: \$29.⁹⁰**

Standard Drawer Slide Mounting Tool

The Drawer Slide Mounting Tool is designed to easily install metallic drawer slides. There is a magnet on each side of the

Drawer Slide Mounting Tool so one tool is used for mounting the track to the cabinet on either side of the drawer. Our mounting tool eliminates the need for measuring and marking because it uses the intersection of the stile and rail as a reference point so that each cabinet track is mounted accurately. The magnetic design improves the ease of use of this tool. It also works with frameless cabinets. The Drawer Slide Mounting Tool can be used to install the hardware for the Blum manufacturer.



ITEM # SDST Standard Drawer Slide Mounting Tool **SALE: \$29.⁹⁰**

Blum Standard 3/4 Extension Drawer Runners

Durable, yet economical, Blum's Standard Drawer Runners are the ideal choice for shops that demand value and reliability. They feature self-lubricating synthetic rollers, tempered steel axles and **BLUMATIC**

self-closing action. They also feature Blum's lifetime warranty, your assurance of quality. Runners include screws, and install in seconds when used with the Drawer Slide Installation Jig. (sold above) Always order slides 2" shorter than the cabinet depth.



Description	Length	ITEM	Sale	10+	25+
Standard Drawer Runner	16"	230M4000	\$4.90/Pr.	\$4.50/Pr.	\$3.50/Pr.
Standard Drawer Runner	18"	230M4500	\$5.00/Pr.	\$4.70/Pr.	\$3.75/Pr.
Standard Drawer Runner	20"	230M5000	\$5.25/Pr.	\$4.590/Pr.	\$3.80/Pr.
Standard Drawer Runner	22"	230M5500	\$5.50/Pr.	\$5.00/Pr.	\$4.00/Pr.

Blum Tandem Concealed Full Extension Drawer Slides

Smooth action, without hiding your craftsmanship



Blum offers a line of Tandem plus Blumotion runners that offer four-dimensional adjustment, increased load capacity, better side stability and many more features and improvements. They feature a unique integrated spring-loaded self-closing mechanism which engages when

the drawer is 2" from closing. It applies carefully-calibrated resistance to the runner's self-closing mechanism, resulting in a soft controlled close.



TANDEM runners don't hide your beautiful joinery and provide quiet soft close features.



Blum's Tandem Concealed Soft Close Drawer Slides for 3/4" Stock

ITEM	Description	Sale	6+
563F3050B	Full Extension 12" Slide w/Blumotion	\$38.90/Pr	\$35.90/Pr
563F3810B	Full Extension 15" Slide w/Blumotion	\$39.90/Pr	\$36.90/Pr
563F4570B	Full Extension 18" Slide w/Blumotion	\$40.90/Pr	\$36.90/Pr
563F5330B	Full Extension 21" Slide w/Blumotion	\$41.90/Pr	\$37.90/Pr

Blum's Tandem Concealed Soft Close Drawer Slides for 5/8" Stock

ITEM	Description	Sale	6+
563H3050B	Tandem BluMotion Runner 12"	\$36.90/Pr.	\$33.90/Pr.
563H3810B	Tandem BluMotion Runner 15"	\$37.90/Pr.	\$34.90/Pr.
563H4570B	Tandem BluMotion Runner 18"	\$38.90/Pr.	\$35.90/Pr.
563H5330B	Tandem BluMotion Runner 21"	\$39.90/Pr.	\$36.90/Pr.

Drawer Mounting Brackets

These mounting brackets are designed to ease the process of aligning a Full-Extension Drawer slide to the drawer box once the slide has been mounted to the cabinet. Brackets are designed to work with both face frame and frameless cabinets.



ITEM # DMB Drawer Mounting Brackets **SALE: \$10.⁹⁰**

GluBot Bottles

The only glue bottle that will not drip or spill!



GluBot Family

Your days of cleaning up glue drips and spills are over, thanks to the Glu-Bot. The unique spill-proof tip puts glue right where you want it, and nowhere else. Includes easy-squeeze glue bottle, blade tip and yorker tip.

ITEM	Description	Sale
GB.BABEBOT	4 oz BabeBot	\$5.90
GB.HIGHBOT	6 oz HighBot	\$6.90
GLUBOT	16 oz GluBot	\$7.90

Glue Bottle Nipple 2Pk

Extend the life of glue, lacquer thinner, acetone and more!



Sommerfeld's has another product available called the GluNip! It is a durable silicone tip to fit over your glue bottle that will not clog because the glue does not stick and will keep your glue fresh! You cut the tip to the desired depth depending on how much of a flow you want to disperse, and you can use it to rub or spread your glue.

It can even be used on other shop solvents like lacquer thinner, acetone, denatured alcohol, etc. It stretches quite a bit so fits on a variety of sizes. It is a great compliment to our 16oz Glu-Bot.

ITEM # GB.GLUNIP **SALE: \$5.90**

16' Standard Reversible Left or Right Self-Adhesive Measuring Tape

The flat 16' standard tape measure is reversible, allowing for left or right read and can also be cut to whatever length you need. Simply adhere the included Speed Tape dots to one side of the tape and stick it on!



ITEM # PS-STICK 16 **SALE: \$14.90**

16' Metric or Standard Self-Adhesive Measuring Tape

This self-adhesive tape measure puts a tape rule right where you need it. The flat 16' standard tape measure is reversible, allowing for left or right read in one tape. It can be cut to whatever measurement you need. Simply adhere the included Speed Tape dots to one side of the tape and stick it on!



ITEM # PMS-STICK 16 **SALE: \$14.90**

16' Professional Tape Measures

- ✓ Compact Casing
- ✓ Pencil Sharpener
- ✓ Lever Action Clip
- ✓ Heavy-Duty 1" Blade
- ✓ Erasable Note Pad
- ✓ Dual-Blade Locks



PSSR-16
Standard measurements read both ways



ITEM # PSSP-16 **SALE: \$10.90**

ITEM # PSSR-16 **SALE: \$10.90**



PSSP-16
Standard measurements with story pole

The Finest Self-Tapping Pocket Cutter Screws

The perfect screws for the Easy Pocket shown below

- Specially designed for pocket cutter
- All screws have a self-tapping auger point that eliminates pilot holes
- All screws have a #2 square drive recess
- All screws are industrial grade - case hardened to eliminate breakage

Two Head Types:

• **Deep Pan Head:** Provides a flat bearing surface under the head for seating in the pocket cutter. Our heads are thicker than the average screw where the head joins the shank, helping to prevent breakage. Pan Head screws are used mostly in face frame assembly.

• **Washer Head:** This oversized head is our most popular cabinet assembly screw. The large washer bearing surface is especially useful when fastening soft materials, plywood, MDF & other man-made materials.

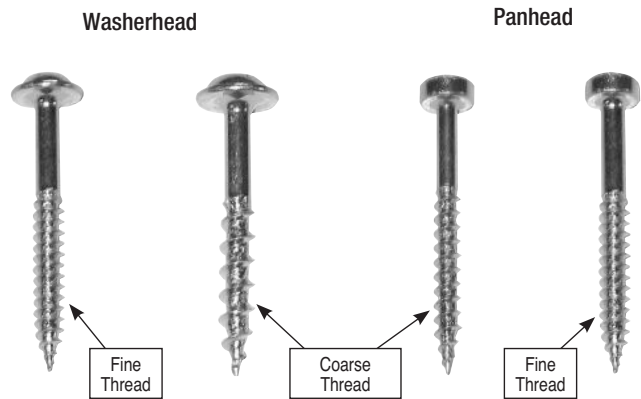

Two Thread Types:

• **Fine Thread:** Used exclusively in harder woods such as Ash, Oak, Maple, Walnut, Hickory, Cherry, Mahogany or Birch.

• **Coarse Thread:** Used in softer woods such as Pine, Cedar, Fir, Spruce, Basswood, Butternut, Poplar, Aspen, Plywood, Melamine, MDF or Particle Board.

Two Lengths:

We only offer two lengths - 1-1/4" and 1-1/2", because of the unique adjustability of the Easy Pocket Jig. We recommend the 1-1/2" length for face frames.

Best Prices anywhere on Pocket-Hole screws!

Description	Length	Thread	Quantity	ITEM	Price	Sale	Description	Length	Thread	Quantity	ITEM	Price	Sale
Washer Head Fine: use in hardwood to hardwood applications							Deep Pan Head Fine: use in hardwoods, primarily in face frame construction						
#7 Washer Head	1-1/4"	Fine	500	WHF4	\$21.90	\$18.90	#6 Pan Head	1-1/4"	Fine	500	FHF4	\$21.90	\$18.90
#7 Washer Head	1-1/2"	Fine	500	WHF2	\$21.90	\$18.90	#6 Pan Head	1-1/2"	Fine	500	FHF2	\$21.90	\$18.90
Washer Head Coarse: use in softwoods, plywood, MDF and other man-made materials							Deep Pan Head Coarse: use in softwoods only						
#7 Washer Head	1-1/4"	Coarse	500	WHC4	\$21.90	\$18.90	#6 Pan Head	1-1/4"	Coarse	500	FHC4	\$21.90	\$18.90
#7 Washer Head	1-1/2"	Coarse	500	WHC2	\$21.90	\$18.90	#6 Pan Head	1-1/2"	Coarse	500	FHC2	\$21.90	\$18.90

Accessories and Parts for your 3-In-1 Pocket Cutter

These top quality parts work with any pocket cutter

Description	ITEM	List	Sale
Toggle Clamp with Spindle	88340	\$18.50	\$10.90
Face Clamp - 1-1/2"	81930	\$25.75	\$14.90
Face Clamp - 2-1/2"	81932	\$27.75	\$16.90
Face Clamp - 3-1/2"	81934	\$29.75	\$18.90
3/8" Step Drill Bit	79130	\$22.80	\$14.90
3/8" Stop Collar & Allen Wrench	81910	\$1.45	\$.50
#2 x 3" Square Drive Bit	81920	\$1.95	\$1.00
#2 x 6" Square Drive Bit	81921	\$3.45	\$2.00

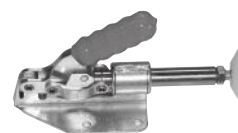

Toggle Clamp with Spindle and Special Non-Marring Tip.



Stop Collar



Face Clamp with Large Pad



Driver Bits

Step Drill Bit

Bent Wrenches

Marc's bent wrench allows you to change bits in seconds from above the top; no need to raise or lower the router.



ITEM	Description	Sale
WR001	Bent Wrench 1-1/8"	\$14.90
WR002	Bent Wrench 13/16"	\$14.90
WR003	Bent Wrench 15/16"	\$14.90
WR004	Bent Wrench 7/8"	\$14.90

Router Bit Bearings

We have bearing replacements for all of our high-quality Sommerfeld's Tools router bits!



ITEM	Outside Diameter	Inside Diameter	Thickness	Sale
608ZZ	22mm	8mm	7mm	\$3.90
688ZZ	16mm	8mm	5mm	\$3.90
693ZZ	8mm	3mm	3mm	\$3.90
698ZZ	19mm	8mm	6mm	\$3.90
HC159CZZ	5/8"	1/4"	3/16"	\$3.90
HC190CZZ	3/4"	1/4"	1/4"	\$3.90
HC222CZZ	7/8"	1/4"	1/4"	\$3.90
HC254CZZ	1"	1/4"	1/4"	\$3.90
HC254DZZ	1"	8mm	1/4"	\$3.90
HC286CZZ	1-1/8"	1/4"	1/4"	\$3.90
HC286EZZ	1-1/8"	1/2"	5/16"	\$3.90
HC293DZZ	1-5/32"	8mm	7mm	\$3.90
HC318CZZ	1-1/4"	1/4"	1/4"	\$3.90
HC318DZZ	1/1/04	8mm	5mm	\$3.90
HC349EZZ	1-3/8"	1/2"	5/16"	\$3.90
R144ZZ	1/4"	1/8"	7/64"	\$3.90
R166ZZ	3/8"	3/16"	1/8"	\$3.90
R1810ZZ	1/2"	5/16"	5/32"	\$3.90
R188ZZ	1/2"	1/4"	3/16"	\$3.90
R2-5ZZ	5/16"	1/8"	9/64"	\$3.90
R3ZZ	1/2"	3/16"	5mm	\$3.90
R4AZZ	3/4"	1/4"	9/32"	\$3.90
R4ZZ	5/8"	1/4"	5mm	\$3.90
SRI1212ZZ	3/4"	1/2"	5/32"	\$3.90

6" Digital Calipers

Finally a caliper with measurements in fractions!

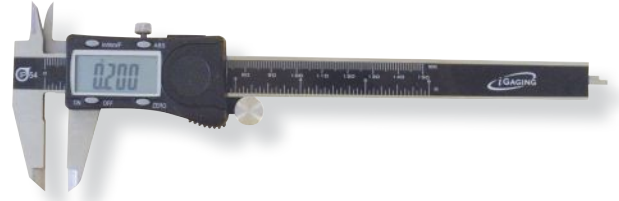

A must for every woodworker, this hardened stainless steel electronic digital caliper is ideal for checking bushings, drill bits, and sizing work where a precise fit is required. This caliper can also be used for inside, outside, step and depth measurements. Unit measures in metric, decimals, thousandths and fractional inches to 6" diameter with the press of a button. A locking screw allows you to lock the caliper in position for measuring and a zero button "zeros" the caliper prior to use. Calipers can be used in conjunction with Sommerfeld's Easy Set Jig (see page 50)

ITEM # 100-333-1G **SALE: \$39.⁹⁰**

Blum Pozi Drive Screwdriver



The ideal driver for installing Blum hardware and screws.

ITEM # BLUMDR Blum Pozi Drive Screwdriver

SALE: \$10.⁹⁰

Push Block



This push block is great for making jigs for your router table! Buy two and save money!

ITEM # PB **SALE: \$4.⁹⁰**
or buy **two** for **\$9.⁰⁰** and save!

Sommerfeld's 16-Pc Forstner Bit Set

Where most forstners have round shanks that can easily slip in drill chucks and galls, Sommerfeld's forstners have rugged, hexagonal shanks, giving you increased gripping power with zero fear of slippage. Designed to produce holes with super-smooth sides and perfectly flat bottoms, results are best when these bits are used in a drill press at a slow speed. Since chip ejection on forstners is notoriously inefficient, it's also best to withdraw the bit from the hole frequently to clear the chips.

Set Includes: 16 bits, with diameters ranging from 1/4" to 2-1/8" , in 1/8" increments. (all with 3/8" shanks)



ITEM	Description	Sale
16001	16-Pc Forstner Bit Set	\$69.90

Trend Tool & Bit Cleaner

18.0 fl oz / 532 ml

Increase the life of your tools!

Extend the life of your tools with this industrial strength non-toxic, biodegradable, wood resin remover. Perfect for blades, bits, files, wrenches, etc. and anything that comes into contact with wood.

This cleaner has unique properties for breaking the molecular bond and lifting the dirt and debris from all surfaces as opposed to dissolving the material like other cleaners.



ITEM	Description	Sale
CLE-500	Trend Tool & Bit Cleaner	\$10.90

2P10 Solo Adhesive

Fast, permanent joints - bonds stronger than wood in seconds!

Our 2P10 Solo Adhesive System is great for bonding the muttoms and mullions of divided light doors, as well as many other jobs around your shop.

2P10 delivers a permanent bond on almost all surfaces. It's easy to use - Just apply the adhesive and spray on the activator. Features a no-clog cap with a metal pin to prevent clogging.



ITEM	Description	Sale
2P10	2P10 Solo Adhesive	\$24.90
2P10-Solo-Thick	2P10 Solo Thick Refills 2.25oz	\$10.00

MIRKA Carat Flex Sheets



Carat Flex is a separate coated abrasive product for dry sanding applications. It has been developed for hand sanding of wood, sealers, paints and lacquers. The backing consists of a flexible, impregnated latex paper, ideal for profile sanding.

The grain adherence is also extremely good. It has a fine stock removal and the silicon carbide grains provide a uniform scratch pattern. The resin over resin

bonding and the separate coating guarantee a long life time.

The grits range from 80x to 400x in the non-loading. The lower grit (80x-100x) sheets can be used for many general purpose applications such as heavy stock removal to light stripping. The higher grits (120x-400x) are generally used for moderate stock removal and between coats of finish.

ITEM	Description	Sale
02-101-080	9"x11" 25 pack 80 grit	\$20.90
02-101-100	9"x11" 50 pack 100 grit	\$31.90
02-101-120	9"x11" 50 pack 120 grit	\$29.90
02-101-150	9"x11" 50 pack 150 grit	\$31.90
02-101-220	9"x11" 50 pack 220 grit	\$31.90
02-101-400	9"x11" 50 pack 400 grit	\$31.90

MIRKA Waterproof Sheets



Mirka Waterproof is recommended for manually wet sanding plastics, lacquer and composite materials. The product has a latex impregnated paper as a backing material and extra durable grit binding.

It can be used on metal and is perfect for sharpening chisels and planes. • Suitable

for wet sanding by hand. • Provides a high-quality sanding finish also on coarser surfaces. • A sanding block is recommended for a smooth sanding pattern. Grits from 220 to 320 are aluminum oxide for sanding putty, removing lacquer or paints and more.

Grits from 400 to 800 are silicone carbide grit and are suitable for finer sanding chores like sanding between coats, finish coats and lacquer.

ITEM	Description	Sale
21-104-P220	9"x11" 50 pack 220 grit	\$48.90
21-104-P320	9"x11" 50 pack 320 grit	\$48.90
21-104-P400	9"x11" 50 pack 400 grit	\$48.90
21-104-P600	9"x11" 50 pack 600 grit	\$45.90
21-104-P800	9"x11" 50 pack 800 grit	\$48.90

MIRKA Hook and Loop Discs



Mirka's Gold hook and loop sanding disc is a durable product very well suited for sanding at high speeds. Gold is an all-around sanding material that can be used for many purposes. In order to achieve an optimal sanding result, the semi-open grit binding and special stearate coatings are designed to prevent clogging and pill forming. These hook and loop discs work

on a wide variety of orbital sanders. The sanding discs are available in 5" 5 hole, 5" 8 hole and 6" 6 hole sizes.

Mirka Gold 5" - 5 Hole Pack

ITEM	Description	Sale
23-614-AP	5" 5 hole Asst. 80, 100, 120, 150 & 220 grit	\$30.90
23-614-080	5" 5 hole 50 pack 80 grit	\$30.90
23-614-100	5" 5 hole 50 pack 100 grit	\$23.90
23-614-120	5" 5 hole 50 pack 120 grit	\$27.90
23-614-150	5" 5 hole 50 pack 150 grit	\$25.90
23-614-220	5" 5 hole 50 pack 220 grit	\$28.90

Mirka Gold 5" - 8 Hole Pack

ITEM	Description	Sale
23-615-AP	5" 8 hole Asst. 80, 100, 120, 150 & 220 grit	\$30.90
23-615-080	5" 8 hole 50 pack 80 grit	\$26.90
23-615-100	5" 8 hole 50 pack 100 grit	\$21.90
23-615-120	5" 8 hole 50 pack 120 grit	\$21.90
23-615-150	5" 8 hole 50 pack 150 grit	\$23.90
23-615-220	5" 8 hole 50 pack 220 grit	\$23.90

Mirka Gold 6" - 6 Hole Pack

ITEM	Description	Sale
23-624-080	6" 6 hole 50 pack 80 grit	\$35.90
23-624-100	6" 6 hole 50 pack 100 grit	\$37.90
23-624-120	6" 6 hole 50 pack 120 grit	\$37.90
23-624-150	6" 6 hole 50 pack 150 grit	\$37.90
23-624-220	6" 6 hole 50 pack 220 grit	\$37.90

MIRKA Contour Sanding Sponges



A sanding sponge with abrasive on one side and can be used wet or dry. This sponge will outlast sandpaper and they are perfect for stripping old finishes. Ideal for sanding contours by hand.

ITEM	Description	Sale
1355-060	Single Sided Abrasive Sponge 4.5"x5.5"x0.25 60 grit Qty 20	\$25.90
1355-100	Single Sided Abrasive Sponge 4.5"x5.5"x0.25 100 grit Qty 20	\$30.90

MIRKA Royal Gold Discs



The Gold Discs achieve fast and efficient stock removal with long life. Gold Discs have a special sterated coating which is designed to prevent clogging.

Mirka Gold 5" PSA Autobox Disc

ITEM	Description	Sale
23-388-080	5" 100 pack 80 grit	\$44.90
23-388-100	5" 100 pack 100 grit	\$39.90
23-388-120	5" 100 pack 120 grit	\$39.90
23-388-150	5" 100 pack 150 grit	\$35.90
23-388-220	5" 100 pack 220 grit	\$38.90

Mirka Gold 6" PSA Autobox Disc

ITEM	Description	Sale
23-379-080	6" 100 pack 80 grit	\$63.90
23-379-100	6" 100 pack 100 grit	\$57.90
23-379-120	6" 100 pack 120 grit	\$51.90
23-379-150	6" 100 pack 150 grit	\$50.90
23-379-220	6" 100 pack 220 grit	\$55.90

Super Project Plans for the Sommerfeld's Junior Set

Miniature Raised Panel Desktop Accessories



Complete plans for this attractive desk set, featuring raised panels that are a great project for the Junior Set.



ITEM # PLAN3
Desk Top Accessories Plans **SALE: \$14.⁹⁰**

Miniature Doll Cradle Plans

This beautiful cradle will surely light up a lucky youngster's eyes. It's also lots of fun to build with your Sommerfeld Junior Raised Panel Set.



ITEM # PLAN2 Mini Doll Cradle Plans
SALE: \$14.⁹⁰

See Page 26 for More Templates

The Sommerfeld's Junior Raised Panel Set

Please see page 20 for complete descriptions and full-size profiles.

ITEM #03002
Jr. Raised Panel Set
SALE: \$119.⁹⁰





Easy Mark Hardware Drilling Jig

U.S. Patent No. 5,813,803

Brings speed, precision and repeatability to drawer and cabinet door hardware installation

The Easy Mark drilling jig will help you align and drill the hardware mounting holes for knobs and handles quickly, precisely and with absolute repeatability. And, when you finish, all handles and knobs will be in perfect alignment with one another... a sight to behold !

If you're still measuring, marking and drilling large numbers of mounting holes without the aid of a device like this, you're wasting a lot of valuable time.

Here's how it works:

- Rest the raised ledge on the back side of the Easy Mark on the top edge of the drawer front
- Slide the horizontal stop all the way to the right and center the device on the drawer front, using the left and right half-scales as indicators

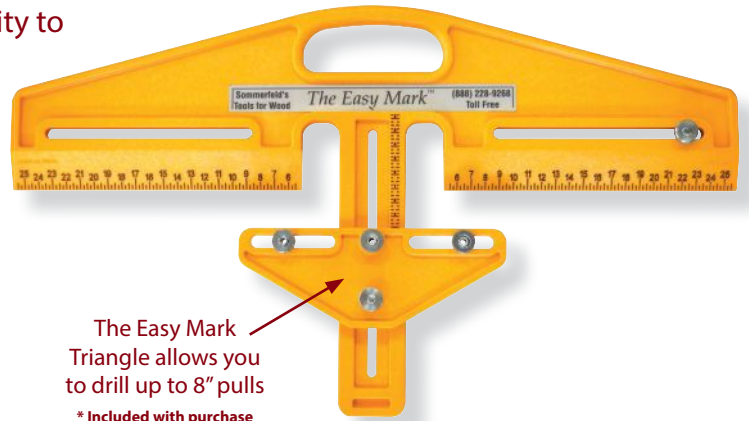

The Easy Mark Triangle allows you to drill up to 8" pulls

* Included with purchase of Easy Mark

- Slide the stop to the left until it makes contact with the right side of the drawer front and tighten
- Adjust drill bushings (3" to 4-1/2" on-center) to match hardware mounting hole(s) and tighten. (Included)
- Loosen the locking knob on the drill bushing block ...slide it vertically to your desired position...and re-tighten the locking knob
- Use a 3/16" twist drill bit in the applicable hardened bushings to bore mounting holes (included)
- Move the Easy Mark to the next drawer and repeat the process

ITEM	Description	Sale
EZM TRIANGLE FRAME	Replacement Triangle	\$14.90
EZM	Easy Mark Hardware Drilling Jig	\$69.90



Sommerfeld's 6-Pc Master Jig Set

This great set combines all of our most timesaving and innovative jigs in one set, as well as our comprehensive DVD set to help you get the most out of our tools — **all yours at a savings of \$64.35**



Easy Mark Hardware Drilling Jig

Marc's Expanded DVD Collection



Easy Bore Hinge Boring Jig



Push Blocks

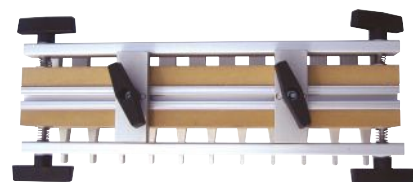

Sommerfeld's Dovetail Jig



3-In-1 Pocket Cutter

ITEM	Description	Sale
DTJ	Dovetail Jig	\$239.90
SHB	Easy Bore Hinge Boring Jig	\$179.90
EZM	Easy Mark Jig	\$69.90
31PC	3-In-1 Pocket Cutter	\$89.90
PBx2	Push Blocks x 2	\$9.00
DVD13PK	DVD 13 Pk	\$54.90
	Total Retail Value	\$643.50
	10% DISCOUNT	\$64.35
SMJS	Sommerfeld's 6-Pc Master Jig Set	\$579.15

Mini Panel & Rail Templates

Perfect for the Sommerfeld Junior Set

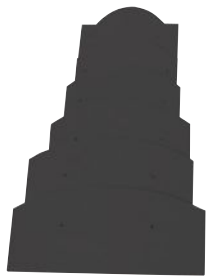

Junior Templates



* See page 73 for plans



Cradle Templates

These sets of durable plastic templates are designed to work perfectly with the Junior Set. (Item # 03002) See page 73 for desk accessories and cradle plans. Junior templates sizes 4-7/8 – 8-3/8 .

ITEM	Description	Sale
TMPJR	Junior Arched Templates	\$19.90
TMPCR	Cradle Templates	\$19.90

Our Unique Panalign Strips

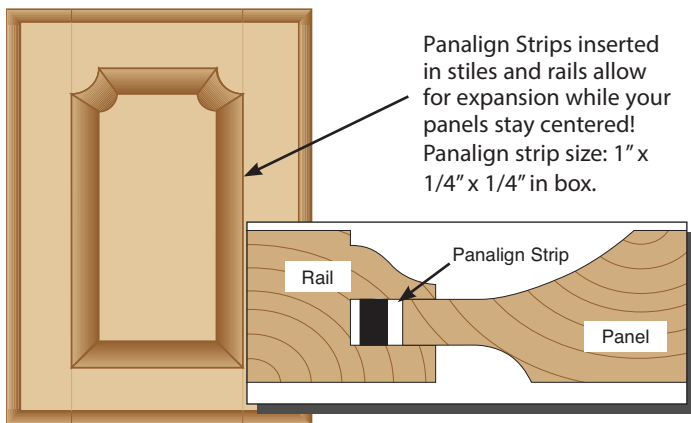

Beautiful panel doors can be ruined by a poorly-aligned panel. On your next door project, slip Panalign Strips into the stiles and rails to keep panels perfectly centered, while allowing for expansion. Unlike carpet foam, which eventually loses elasticity and ceases to work, the rubber in Panalign Strips is specially designed to spring back indefinitely. They are also the solution for a panel that has been sanded so much that it is loose and rattles: inserting the strips keeps the panel snug but not fixed. The rectangular shape makes the strips easy to handle. Typical doors require 4 to 8 strips each.

Description	Quantity	Item	Sale
Panalign Strips	200	PNL1	\$9.90
Panalign Strips	500	PNL2	\$16.90
Panalign Strips	1000	PNL3	\$28.90

Rugged Doormaking Templates

French Provincial



Classic Country



Cathedral



Roman



Sommerset



- **Buy Two Sets** **Save** **\$20.00**
- **Buy Three Sets** **Save** **\$30.00**
- **Buy Four Sets** **Save** **\$40.00**
- **Buy Five Sets** **Save** **\$50.00**

Some woodworkers have avoided making arched raised panel doors for two reasons: the difficulty of making arched cuts and the expense of hold-down jigs. This system solves both problems by eliminating the need for high-cost hold-down jigs. (See catalog pages 28-29 showing step-by-step instructions for template use) Each of our five twenty-piece template packages includes ten sizes for the panels and the ten corresponding templates for the matching arched rails. Each template is individually stamped with its size which indicates overall door width; any door between 9-1/2" and 22" can be made. All templates are made of rugged HDPE plastic for years of use.

Description	Item	Sale
French Provincial Template Set	TMP1	\$69.90
Classic Country Template Set	TMP2	\$69.90
Cathedral Template Set	TMP3	\$69.90
Roman Template Set	TMP4	\$69.90
Sommerset Template Set	TMP5	\$69.90

Tips and Techniques for Creating Raised Panel Doors

STEP 1. MAKING A SAMPLE DOOR

- A) This sample door size is 12" wide by 20" long.
- B) The door thickness should be 3/4" - 7/8"

STEP 2. DETERMINING THE SIZES OF EACH PART OF THE DOOR

- A) Always use a 1/2" overlay on all sides of the door.
- B) If the door opening is 11" wide by 19" high then the door size is 12" x 20".

IMPORTANT: Use 2-1/2" wide stiles so the templates will work properly.

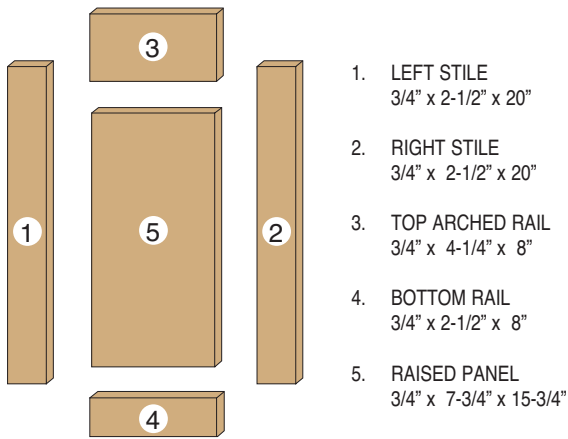

1-2. LEFT AND RIGHT STILES

- A) Always cut stiles 2-1/2" wide.
- B) Length of stiles is same as door length.

3. TOP ARCHED RAIL

- A) Cut 4-1/4" wide. Templates are 4" wide. **(Cut 5-1/4" wide for French Provincial doors)**
- B) Length of rail is found by subtracting 4" from the total door width. (Overall door width is 12" minus 4" = 8" length of rail) **NOTE:** This following procedure can only be used when using 2-1/2" wide stiles. Subtract 4" from the total door width instead of 5" since 1/2" in each stile will be taken up in the pattern cut.

4. BOTTOM RAIL

- A) Always cut 2-1/2" wide.
- B) Length of rail is again found by subtracting 4" from the total door width. (Overall door width is 12" minus 4" = 8" for bottom rail lengths)

5. RAISED PANEL

- A) Width is always 1/4" less than rail length. (1/8" space should be left on each side for expansion of panel)
- B) Rail length is 8" minus 1/4" = 7-3/4" width of raised panel.
- C) Length of raised panel is found by taking the overall door length and again subtracting 4". (Overall door length is 20" minus 4" = 16", or 15-3/4" with paneling strips)

At this time all 5 pieces of the door should be the correct size.

STEP 3. CUTTING THE COPE CUTS ON EACH END OF THE 2 RAILS

- A) Cope cutter is the cutter with the bearing in the middle
- B) Set the cope cutter to the correct height in the router.
 - 1) The correct height is when, after the cut is made, the reveal on the front side should be 1/8" minimum (Illustration 1)
 - 2) Spaces A and B shown should be equal. If one is to be bigger, make B thicker for strength of panel.

C) Set fence even with bearing.

D) Use wooden push-block to prevent tearout at end of cope cut.

E) Run stock through with good side down at 14,000-16,000 RPMs.

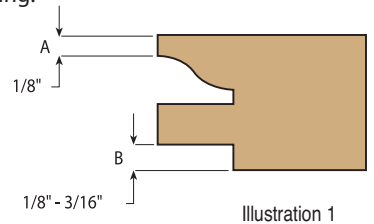

Illustration 1

STEP 4. USING RAIL TEMPLATE TO FLUSH TRIM TOP RAIL TO CORRECT SHAPE

A) Locate center of top rail with pencil on the back side.

B) Pick out the correct template.

NOTE: THE SIZE ON THE TEMPLATE IS FOR THE OVERALL DOOR WIDTH. FOR THE TEMPLATES TO WORK PROPERLY STILES MUST BE MADE 2-1/2" WIDE. IF STILES ARE MADE IN DIFFERENT WIDTHS, ADJUSTMENTS IN PICKING OUT TEMPLATES MUST BE MADE.

C) Line up template on back side of rail centering the notch of template with center line of rail. Now nail through the template into the 2 copes that were just cut (Illustration 2).

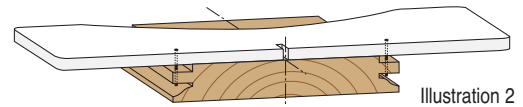

Illustration 2

D) Rough cut with jig or band saw within 1/8" or 1/4" of template (Illustration 3).

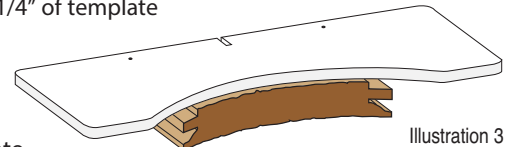

Illustration 3

E) Put flush trimming bit into router and set so bearing is flush with template (Illustration 4).

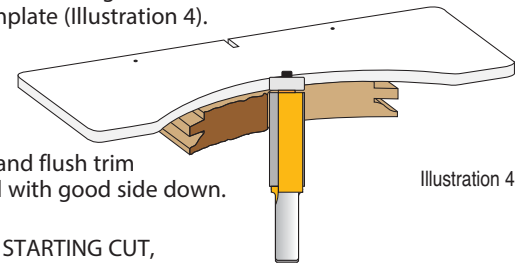
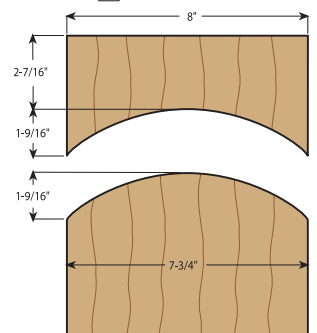

Illustration 4

F) Run router at 20,000-22,000 RPMs and flush trim top crown rail with good side down.

NOTE: WHEN STARTING CUT, ALWAYS REMEMBER TO MAKE CONTACT WITH BEARING TO A PLACE ON THE TEMPLATE WHERE THERE IS NO WOOD TO PREVENT KICKBACK.



G) Slow down at end of cut to prevent tearout. Leave template attached to rail for now

STEP 5. USING PANEL TEMPLATE TO FLUSH TRIM THE RAISED PANEL TO SHAPE

- A) Locate center of raised panel on front side.
- B) Pick out correct template (same size as rail template).
- C) Line up center notch of template with center line of panel and make sure it is also square (Illustration 5).
- D) Nail template to panel about 1/2" in from each side (Illustration 5).

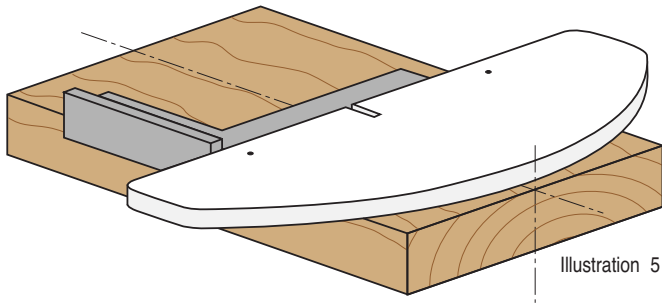

Illustration 5

NOTE: DRIVE NAILS IN ABOUT 1/4"-3/8". THE NAIL HOLES WILL BE MACHINED OUT WHEN RAISED PANEL CUT IS MADE.

- E) Rough cut stock to within 1/8" - 1/4" of template.
- F) Flush trim raised panel in the same manner as you did the top rail with the template on top (Back to illustration 4).
- NOTE:** AGAIN MAKE SURE BEARING COMES IN CONTACT WITH TEMPLATE FIRST AND THEN GUIDE INTO THE WOOD.
- G) Pull nails out after flush trimmed.

STEP 6. CUTTING FREEHAND PATTERN CUT ON TOP ARCHED RAIL

- A) Pattern cutter is the cutter with the bearing on top.
- B) Insert pattern cutting bit to correct height to match cope cut. This can be done by making a few practice cuts in scrap wood.
- C) Run router at 14,000-16,000 RPMs.
- D) Start cut with bearing making contact with template only and ease into cut. No fence is used. (Illustration 6).
- E) Slow down at end of cut to prevent any chipout.
- F) Remove template from top arched rail.

STEP 7. CUTTING THE STRAIGHT BOTTOM RAIL AND 2 STILES

- A) Insert fence and line up fence with bearing on the same pattern cutter.
- B) Run router 14,000-16,000 RPMs
- C) Use push block and push bottom rail through with good side down.

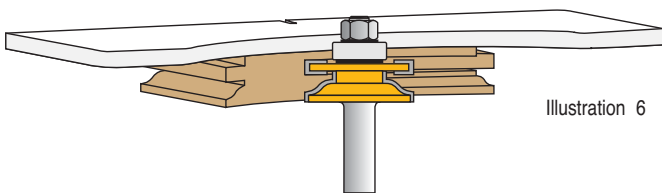

Illustration 6

STEP 8. MAKING RAISED PANEL CUT

- A) Insert panel cutter to correct height.
NOTE: IT MAY TAKE A COUPLE OF PRACTICE CUTS IN SCRAP WOOD BEFORE GETTING THE PANEL FLUSH WITH PATTERN CUT.
- B) Set fence so it is even with bearing on panel cutter.
- C) Run router slow 10,000 RPMs. ALWAYS USE PUSH BLOCKS FOR SAFETY.
- D) Make first cut across the grain with good side face down.
- E) Cut with the grain on left side.
- F) Remove fence and use a half-fence. (Illustration 7)
- G) Start by re-doing left side and come around and cut the curved top of the panel freehand.
- H) Install full fence and complete right side.

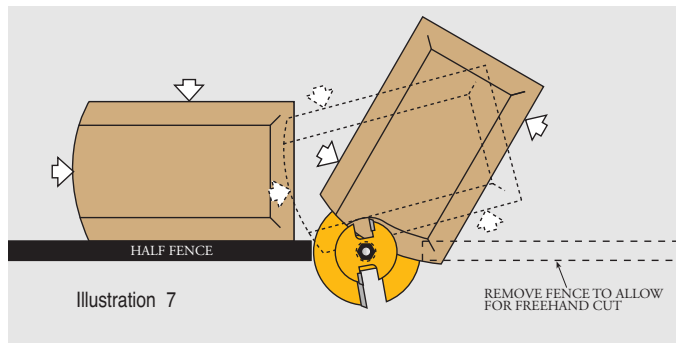

Illustration 7

REMOVE FENCE TO ALLOW FOR FREEHAND CUT

STEP 9. FINISHING

- A) Sand all pieces where needed, insert Panalign Strips (see catalog page 26), and glue up. Do not glue raised panel itself, only cope cuts and where they meet the pattern cuts.
- B) After the door is sanded, use the door edger bit for a professional-looking edge treatment. (Illustration 8)
- C) For a mini-raised panel cut on the drawers, use the drawer front bit. (Illustration 9)

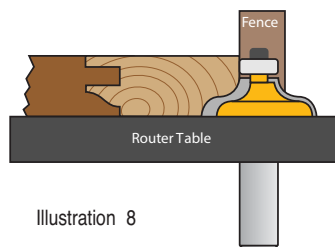

Illustration 8

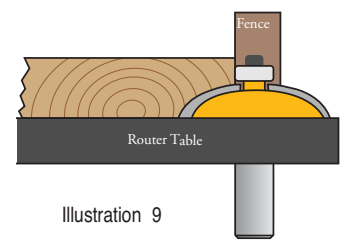

Illustration 9

For more help order our video "Arched Raised Panels Made Easy," showing everything here in much greater detail.

Buy this DVD with the Sommerfeld Cabinetmaking Set (page 13) or Raised Panel Set (page 12) and Save \$5.00!

DVD: DVDS1
SALE: \$4.90



Fine-Tuning Your Rail & Stile Bits and Techniques for Perfect Joints

Sommerfeld's matched Rail & Stile Sets are designed to deliver perfect joints, right out of the box. There are many factors that affect the fit of these joints, however. These include the condition of your router, the species of wood you choose, your routing technique, and more. Of course, resharpening the bit can also affect the final fit. In order to allow you to compensate for these

variables, Sommerfeld's makes both bits out of two separate sections, which can be shimmed to adjust the fit. Please note that only shimmed cutters can be corrected in this fashion. There are six common problems that can occur when using your Rail & Stile Sets. Here are the solutions that we have developed through years of experience:

Problem #1:

The joint doesn't close

Profiles seem to match, but there is a consistent gap the full height of the joint.

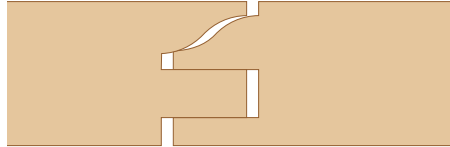

Solution:

The stock probably is not coming in contact with the bearing as you make the cut. Be sure you are cutting the full profile.

Problem #2:

The stock does not lay flat when the joint closes

The profiles match, but the faces of the stiles and rails are not flat.

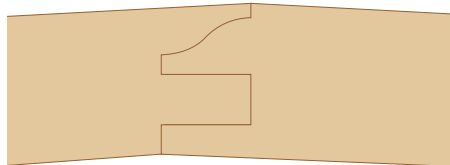

Solution:

The edge of your stock is not cut or planed square to the face.

Problem #3:

Joint is too loose or too tight in the Mortise & Tenon.

The pattern portion of the joint matches, but the tenon is too thick or too thin.

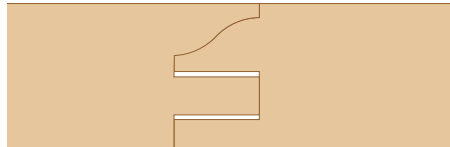

Solution:

Add or subtract shims in this portion of the cope cutting bit, either above or below the bearing. Adding shims will make the tenon tighter. Subtracting shims will loosen the joint.

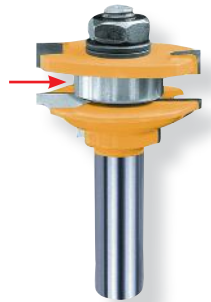

Problem #4:

Joint is too loose or too tight in the pattern area.

The mortise and tenon fits well, but the pattern is too tight or too loose.

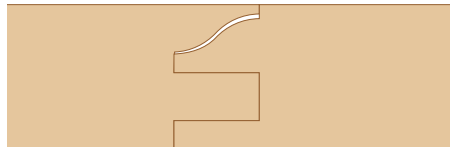

Solution:

First, be sure the tenon is fitting correctly. Now add or subtract shims in this area of the pattern cutting bit. If there is a gap between the pattern cuts, add shims. If the profiles are too tight, remove shims.

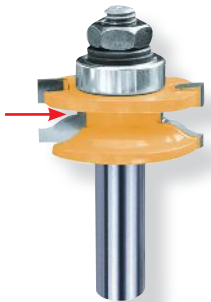

Problem #5:

Joint is misaligned.

The profiles match, but the faces and backs of the rail and stile are offset.

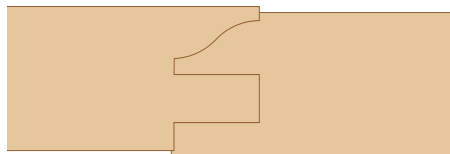

Solution:

This joint usually results from the cutters being misaligned. Raise or lower the pattern cutting bit to adjust the joint.

Problem #6:

Surfaces are not flat.

One surface is flush (either the face or the back), but the other surface is offset.

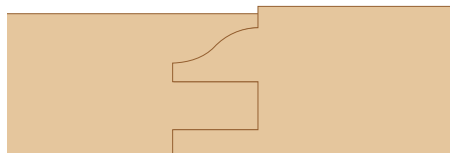

Solution:

This problem is caused by two pieces of stock of different thicknesses. Be sure that all stock used for rails and stiles is of the identical thickness, and always rout with the "good" or "face" side down. We recommend 13/16" stock.

Use this form for mail or fax orders

Copyright © 2018, SOMMERFELD'S TOOLS FOR WOOD
Any reproduction in whole or in part is prohibited.

BILL TO:

Name: _____

Address: _____

City/State: _____

Zip Code: _____

Daytime Phone Number: () _____

Email: _____

SHIP TO: (If different than "Bill To")

Name: _____

Address: _____

City/State: _____

Zip Code: _____

Daytime Phone Number: () _____

ITEM	Qty	Pg	Description	Price	Total

METHOD OF PAYMENT				Total Sale:
<input type="checkbox"/> Personal Check <input type="checkbox"/> Money Order Returned Check Policy: You will be billed for the original amount of the check, plus a \$25.00 bank fee.				Iowa Residents Add Sales Tax
Card# <input type="checkbox"/> Mastercard <input type="checkbox"/> Visa <input type="checkbox"/> Discover <input type="checkbox"/> Amex _____ _____ X _____ Signature (For Credit Card Orders)				Shipping on orders Under \$25. ⁰⁰ please add \$4.90
Expiration _____				Special Shipping Exceptions Below
Security Code _____				Fence Only + \$22.50
				Table Top Only + \$32.40
				Table Top & Fence + \$54.90
				Grand Total \$

How To Order:



Phone:
888-228-9268



Web Site:
www.SommerfeldTools.com



Mail:
1408 Celebrity Rd,
Remsen, IA 51050



FAX:
712-786-2770

TELEPHONE ORDERING: Personalized service is provided Monday - Friday 8-5 Central Time.

WEBSITE: You can order 24 hours a day, 7 days a week from our secure website.

CUSTOMER SERVICE: Questions regarding products or an order, call 888-228-9268 or email: ml@sommerfeldtools.com

* Prices subject to change without notice. Not responsible for errors in this catalog.

SHIPPING EXCEPTIONS

There are no shipping or handling charges on any order over \$25.⁰⁰, except for router table tops and fences. Shipping outside the contiguous United States will be subject to shipping charges.

Limited Lifetime Warranty:

We stand behind every tool we sell with a simple guarantee. If you have a problem with one of our tools before resharpening, return it for exchange or credit. This warranty is subject to the following:

- Dullness due to usage of the tool is not covered by this warranty.
- Warranty does not cover ordinary wear and tear.
- Misuse or abuse of the tool will void this warranty.

BACKORDERS: In case of a backorder, we will ship the ITEM as soon as it is available. Your account will not be charged until the time of shipment.

EASY PAYMENT OPTIONS: We accept Visa, Mastercard, Discover, American Express, PayPal or money orders. We never charge credit cards until the ITEM ships. We offer open accounts to schools, institutions and government agencies.

RETURNS & GUARANTEE: We pledge to you the best service we can provide with personal attention and the best value on every order. If you are not satisfied for any reason, call for a return authorization number and then return your purchase within 60 days. You can choose to either exchange the product or receive a complete refund on the purchase price. **TRITON ROUTER WARRANTY - ALL WARRANTY ISSUES AND SPARE PARTS WILL BE RESOLVED BY TRITON TOOLS EXCLUSIVELY: 980-297-7257. Customers are responsible for the shipping expense of all returns - No exceptions.**

SOMMERFELD'S TOOLS FOR WOOD

1408 Celebrity Drive
Remsen, IA 51050



Sommerfeld's Professional Cabinetmaking System

Everything you need to build premier-quality cabinets...all yours at a super \$171.90 savings!



ITEM	Description	Sale
SORS	Sommerfeld's Router Table System	\$549.90
TRA001	3-1/4hp Triton Router	\$249.90
03004	3-Pc. Tongue & Groove Set	\$109.90
06001	6-Pc. Cabinetmaking Set	\$259.90
TMP	Template Set (your choice of one)	\$69.90
DVD13PK	Complete Set of (13) How-To-DVD's	\$54.90
EZSET	Easy Set-Up Jig	\$29.90
PB	Push Blocks (2)	\$8.00
WR003	Offset Collet Wrench	\$14.90
31PC	3-In-1 Pocket Cutter	\$89.90
EZM	Easy Mark Hardware Drilling Jig	\$69.90
SHB	Easy Bore Hinge Boring Jig	\$179.90
FG	Unique Featherguards (2)	\$39.90
	Total Retail Value	\$1,726.80
	YOU SAVE	\$172.68
	Shipping	\$54.90
SPCS	Sommerfeld's Professional Cabinetmaking System	\$1609.02

Or

Create Your Own Personal Cabinetmaking System

To qualify you must purchase the Router Table Top, Fence & Router. The DVD13PK and Offset Collet Wrench are included for free and any additional items in our catalog you will receive **10% OFF** at the time of purchase to help you create your own Personal Cabinetmaking System!

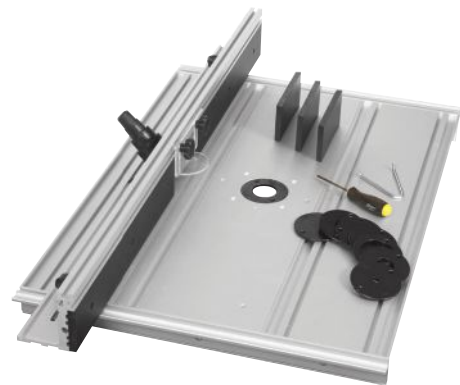

Free Bent Wrench & DVD 13-Pack



ITEM	Description	Sale
SPCS2	Personal Cabinetmaking System	\$807.80

Order Line: 1-888-228-9268